

Instruction Manual

Caravelle and Transporter



www.vwT4camper.info - a useful website for owners and enthusiasts of VW T4 Transporter Campervans

How you can help the environment

The fuel consumption of your Caravelle/Transporter – and thereby the pollutant content in the exhaust gas – are also determined by the way you drive.

Noise and wear are also influenced by the way the car is used.

This Instruction Manual explains how to drive your Caravelle/Transporter in a

way that is compatible to the environment – and save money at the same time. Just turn to the heading "Environment" in the alphabetical index.

Please note also all tests in this manual marked with this symbol 

Please do your bit – for the sake of the environment

We thank you for the confidence you have placed in us through the purchase of the new Caravelle/Transporter.

The new Caravelle/Transporter has been completely redesigned. In this process the years of experience with several million Transporters and front wheel drive passenger cars has been put to good use.

The new Caravelle/Transporter is distinguished by the generous amount of inside space it offers and by its modern aerodynamic styling. In addition it also has a high payload, variability, driving comfort and driving safety.

Environmental factors played a large part in its design, selection of materials and manufacture. The result speaks for itself: The Volkswagen is thrifty with petrol is low pollutant, only requires a small amount of servicing at long intervals, has extremely long-life wearing parts and is extensively recyclable. Therefore it has all the typical Volkswagen virtues such as, economy, quality, reliability and value retention.

It is also reassuring for you to know that one of the largest and most efficient organizations in the world is available to look after your Volkswagen. In Europe alone there is a network of about 9000 Volkswagen dealers that work economically and professionally in accordance with factory guidelines.

The Volkswagen dealers also guarantee that everything is OK on your Caravelle/Transporter. They offer you

- 1 year warranty against defects – with no mileage limit

In the majority of countries there is a complete package of additional warranty cover and services offered, like for example:

- 6 years warranty against rusting-through on the bodywork – without expense for interim treatment.
- 1 year warranty on workshop repairs
- 1 year warranty on all genuine parts and on Volkswagen accessories approved by us.
- The quick, value for money Express Service for the smaller jobs
- A reasonably priced replacement car for the period that yours is being serviced or repaired – ask your dealer.
- The Volkswagen Accessory Service
Tested, factory approved accessories and the professional installation – hereto please also read the note on Page 116.

Volkswagen dealers will gladly supply details on the above-mentioned services and possible country specific deviations. Please see also the notes in the Service Schedule.

We wish you pleasant and safe motoring at all times.

Your VOLKSWAGEN AG

VEHICLE LITERATURE

In the vehicle wallet you will find, in addition to this **Instruction manual**, a **Service Schedule** and a **Service address list**.

Also depending on vehicle model and equipment there can be various Supplements (e.g. for car radio, Multivan or Camper).

If one of these publications appears to be missing or you have the impression that the information on some equipment or model version is not complete, please contact your Volkswagen dealer. He will be pleased to help you.

You can naturally also get in touch direct with our Service Department or with the Importer in your country. The telephone numbers and addresses are to be found in the Service address list.

The Instruction Manual

should be read carefully as soon as possible so that you get to know your vehicle quickly.

Your special attention is drawn to the chapter "Driving tips" in this instruction manual. There you will see how you can drive **safely, economically and environment consciously**.

For safety reasons please note also the information on Accessories, modifications and the renewal of parts on page 117.

The other chapters are of course also important because the correct operation of the vehicle serves – in addition to regular care and maintenance – to maintain the value of the vehicle. www.t4camper.info - a useful website for owners and enthusiasts of VW T4 Transporter Campervans

of the stipulations for upholding warranty claims.

At the end of this manual we have made a list of the checks which you should carry out regularly to keep your vehicle roadworthy at all times.

The Service Schedule

contains

- identification data for your car
- the Service intervals
- the Service operations
- important details about Warranty

Service work which has been carried out is also confirmed in the Service Schedule. This can be important when a claim is made under Warranty.

You should always present the Service Schedule when taking the vehicle to a Volkswagen dealer.

The Service address list

contains

- addresses and telephone numbers of Volkswagen dealers in Europe and overseas.
- important information on the Volkswagen dealer emergency services

Notes on the layout of this Manual:

It describes the largest possible range of equipment envisaged at the time of going to press. Some of the equipment may be available later on or not at all or will not be offered in certain Export markets.

Items of equipment marked with a * are only standard on certain model versions or are only available as optional extras on certain models.

All blocks of text which have this colour backing and the title "Attention" refer to potential accident or injury risks.

 **Texts following this symbol and printed in italics are important notes on environmental protection.**

One final request:

When you sell your car please give the complete Vehicle Wallet to the new owner because the vehicle literature belongs to the vehicle.

DASHBOARD AND CONTROLS

Layout	4
Warning lamps	6

CONTROLS AND EQUIPMENT

Keys, Central locking system	7, 8
Doors, Tailgate	9, 10
Wing doors	11
Windows, Mirrors	12, 13
Seat belts	15
Safety for children	18
Head restraints	19
Seats	20
Loading/sleeping surface	26
Luggage compartment cover	27
Luggage compartment/load surface	28
Pedals, Brakes	29
Manual gearbox	31
Automatic gearbox	32
Ignition lock	36
Starting / Stopping the engine	37, 38
Instruments	40
Warning lamps	47
Switches	50
Turn signal and dip lever	52
Cruise control system	53
Windscreen wiper	54
Heating and ventilation	55
Air conditioner	57
Recirculating air switch	61
Auxiliary heater	63
Additional water heater	67
Sun roof, Sliding/tilting roof	70, 71
Interior lights, Sun visors	72, 73
Ashtray, Cigarette lighter	73
Roof rack	75

DRIVING TIPS

The first 1500 km – and afterwards	76
Driving safely	78
Driving economically and ecologically	79
Trailer towing	81

GENERAL MAINTENANCE

Filling the tank, Fuel	85, 86
Care of car, Maintenance	88, 93
Bonnet, Engine compartment	94, 95
Engine oil, Gearbox oil	96, 99
Air cleaner	100
Power assisted steering	100
Cooling system	101
Brake fluid	104
Battery	106
Windscreen washer system	108
Wheels	110
Arduous operating conditions	115
Winter driving	116
Accessories, modifications and renewal of parts	117
Mobile telephones and two way radios	117

DO-IT-YOURSELF

First aid kit, Warning triangle	118
Vehicle tools	118
Spare wheel/changing wheel	119, 120
Fuses	122
Changing bulbs	124
Adjusting/masking headlights	128, 129
Headlights	129
Installing radio	129
Emergency starting	130
Tow starting/towing	132
Lifting vehicle	134

TECHNICAL DESCRIPTION

Engine	136
Emission control system	137
Activated charcoal filter	138
Power flow	139
Steering, Axles	139
Brakes, Body	139, 140
Environment compatibility	140

TECHNICAL DATA

Engine	141
Performance	142
Fuel consumption	143
Spark plugs	145
V-belts	145
Wheels, Tyre pressures	146, 147
Weights, Trailer weights	148, 151
Dimensions	152
Capacities	153
Vehicle identification data	154

SPECIAL INFORMATION

Adjusting the brake pressure regulator	155
--	-----

ALPHABETICAL INDEX

Alphabetical index	156
--------------------------	-----

CHECKS WHEN FILLING THE TANK

Overview	160
----------------	-----

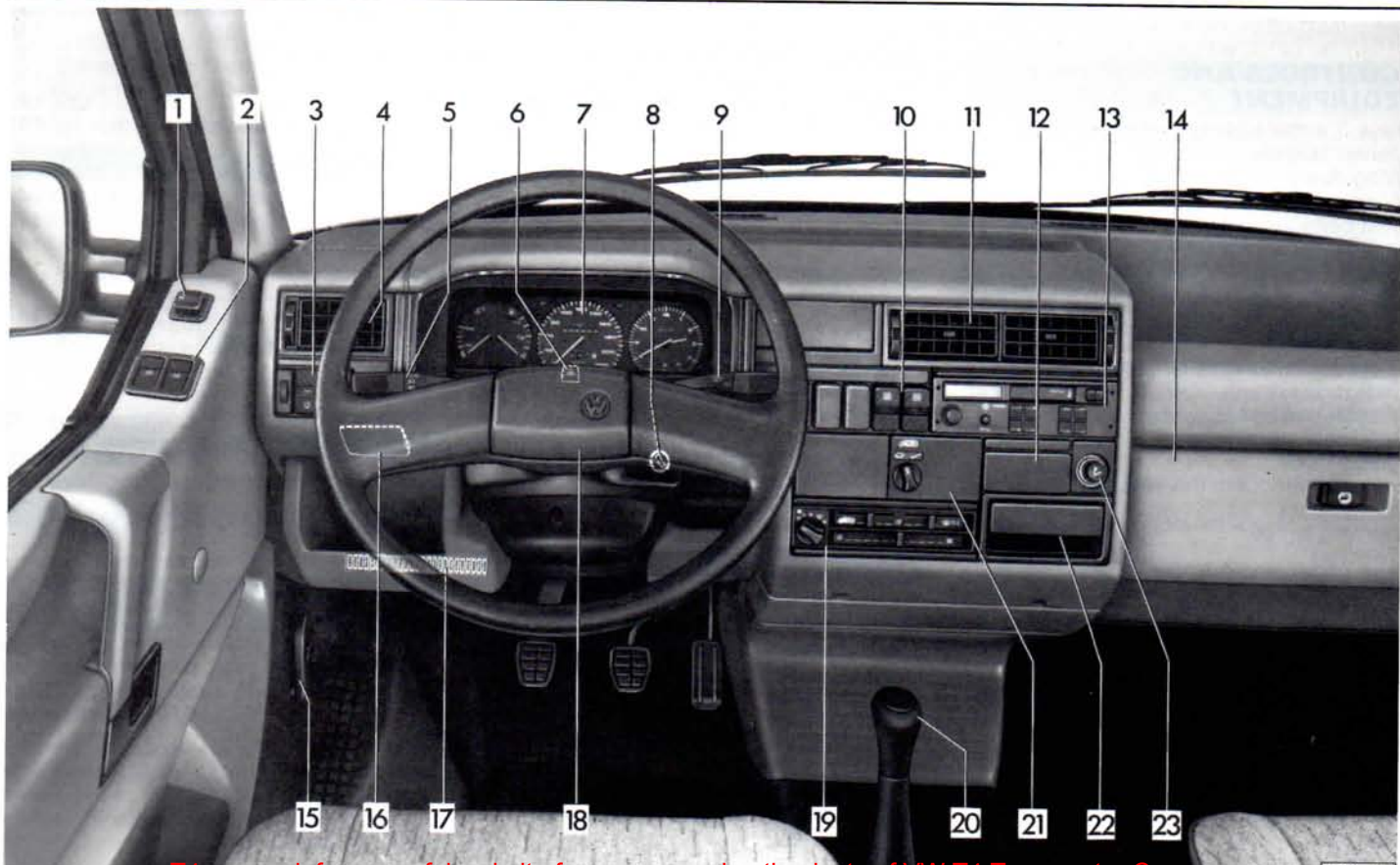

www.vwT4camper.info - a useful website for owners and enthusiasts of VW T4 Transporter Campervans

	Page
1 Remote controlled outside mirror	13
2 Switch for electric windows	12
3 Switches	50
4 Air vents	55, 58
5 Turn signal and headlight dip lever Cruise control system	52 53
6 Emergency light system switch	51
7 Combi instrument: Warning lamps Instruments	47 40
8 Ignition lock	36
9 Windscreen wiper/washer lever with switch for multi function indicator	54 42
10 Switches	50
11 Air vents	55, 58
12 Space for auxiliary heater controls	63
13 Radio ¹⁾	
14 Glove box	74
15 Bonnet release handle	94
16 Cold starting aid (Diesel engines)	38













	Page
17 Fuse box behind shelf	122
18 Horn (only functions with ignition switched on)	
19 Controls and switches for heating/ventilation ... air conditioner	55, 57
20 Gear lever (manual gearbox) Selector lever (automatic gearbox)	31 32
21 Switch for recirculating air	60
22 Ashtray	73
23 Cigarette lighter/electric socket	73



Notes

- Some of the items listed are only fitted on certain models or are optional extras.
 - On righthand drive vehicles the arrangement of the switches and the location of some items can vary. The symbols on the switches are the same as for lefthand drive vehicles.
- ¹⁾ Vehicles with a factory fitted radio have a radio instruction leaflet supplied. When service installing a radio pay attention to the instructions on page 129 in the "Do-it-yourself" section.

DASHBOARD AND CONTROLS

Warning lamps

Symbol		Page
	Coolant temperature/ Coolant level 	47
	Engine oil pressure 	47
	Headlight high beams	48
	Turn signals	49
	Brake system 	48
	Alternator 	49
	Glow plugs – Diesel	49
	Anti-locking brake system (ABS)	49
	Trailer turn signals	49

Symbol		Page
	Emergency light system	51
	Rear window heating	51
	Fog lights rear fog light	51

Notes

- If one of the lamps marked with  comes on when driving, stop and switch engine off. Details can be found on the pages given.
- Some of the lamps shown here are only on certain models or are optional extras.

Keys

The vehicle is supplied with two keys. These keys fit all locks on the vehicle.

Attention
When leaving the vehicle unattended – even if only for a few moments – always take the keys with you.

Key tag

The key number is on the plastic tag. With the aid of the number, a replacement key can be ordered from a Volkswagen dealer. It must then be stated if it is the main key or the second key.

The tag should be kept safely and separately (in your wallet for example) so that no unauthorized person can order a key.

In addition to the plastic tag there may also be a metal tag on which there is a part of the vehicle identification number. This tag is no longer required after vehicle has been delivered.

Central locking system*

With this system all the doors, and – depending on the position of the tailgate or wing door lock – the tailgate or wing door can also be locked and unlocked.

The system is operated from the **driver's door** or **front passenger door** – from outside with the key, from inside with the locking knob.

Note

The central locking system can only function correctly when the driver's and front passenger doors are properly closed.

When locking, the locking knobs on all doors must move down. If the knob on one door does not move at any time, open the door concerned and close it properly.

Attention

■ **When the locking knobs in the driver's or front passenger doors are pressed down all other doors are locked automatically. Since it would be difficult to render assistance from the outside in an emergency, when the doors are locked, children should never be left in the vehicle on their own.**

■ **Locking the doors can prevent them from bursting open in an extraordinary accident situation. Locked doors also prevent persons from entering the car forcibly e.g. at traffic lights. However, in an emergency they make it more difficult for outside help to open the doors.**

Notes:

If the central locking system should develop a fault, all the locks can be operated normally, see next page.

The sliding door can be secured or released separately with the safety catch.

Sliding door and tailgate or wing door can be locked or unlocked separately with the key.

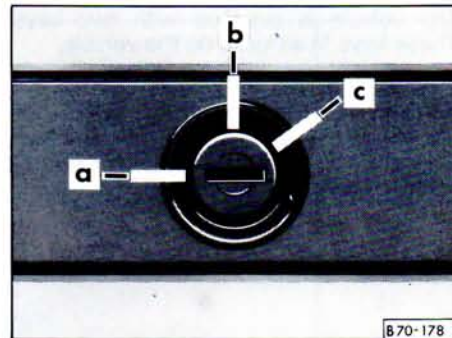

To unlock the tailgate or wing door insert key and turn it to right (c). Hold in this position and press button in.

If the key is withdrawn in the horizontal position (a), locking of the tailgate or wing door will be controlled by the central locking system when it is closed again.

When the key is withdrawn in the vertical position (b) and tailgate or wing door closed, it will be locked all the time. The tailgate can then only be unlocked with the key.

Doors

Cab doors

From outside the front doors can be locked or unlocked with the key. When unlocking, the locking knobs go up, when locking they go down.

The front passenger door can be locked from outside without using the key: Just press locking knob down and close door.

The driver's door cannot be locked when open by pressing the locking knob down and closing door. This prevents you from leaving the key in the car and forgetting it.

From inside all the doors can be locked by pressing down the locking knobs.

As long as the knobs are pressed down the doors cannot be opened from inside or outside.

Attention

Locking the doors can prevent them from bursting open in an extraordinary accident situation.

Locked doors also prevent persons from entering the car forcibly e.g. at traffic lights. However, in an emergency they make it more difficult for outside help to open the doors.

Sliding door

From outside, the sliding door can be locked and unlocked with the key.

The sliding door can also be locked from outside without using the key: Press locking knob down and close door.

From inside, the sliding door is locked by pushing down the locking knob.

As long as the knob is pressed down the door cannot be opened from inside or outside.

When the vehicle is moving, the door must always be properly closed, but when carrying passengers the locking knob should be left in the upper position so that the door can be opened from outside in an emergency.

Note

In the opened position the sliding door is held open by a retainer.

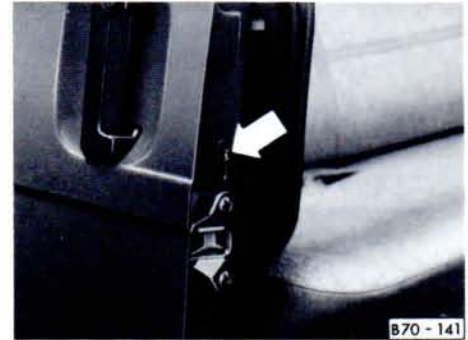

Child-proof catch

When the child-proof catch is engaged – lever on door lock down – the inner lock release lever is inoperative. The door can only be opened from outside with the locking knob in the up position.

Tailgate

To open the tailgate when key slot is horizontal, pull control behind finger strip on tailgate and lift tailgate.

To open from inside

On the inside of the tailgate there is, depending on model, either an opening lever or an emergency lock release which can be reached through a hole in the trim. This makes it possible for vehicle occupants to leave the vehicle via the tailgate in an emergency.

Child proof lock*

Vehicles with an opening lever on the inside of the tailgate are fitted with a child proof lock.

When the child proof catch is engaged – lever on lock moved down – the inner lever is blocked. The tailgate can then only be opened from outside.

To close tailgate pull it down and slam it to gently.

To make the tailgate easier to pull down there is a loop on the inside.

Attention

■ **After closing the tailgate always pull up on it to make sure that it is properly closed – otherwise it could open suddenly when vehicle is moving, even though the key has been turned in lock.**

■ **The tailgate must always be fully closed when vehicle is moving, otherwise exhaust gas will be drawn into the vehicle interior!**

Wing doors*



Righthand door

From outside the wing door can be locked and unlocked with the key. When unlocking the locking knob goes up, when locking it goes down.

From inside the door is locked by pressing down the knob.

As long as the knob is pressed down the door cannot be opened from inside or out.

In the fully open position (approx. 90°) the door is held by a check strap.



Lefthand door

The lefthand door can be opened when the righthand door is open.

To open, pull release lever (see illustration) and open door.

Note

When closing the wing doors always ensure that the left door is closed first.

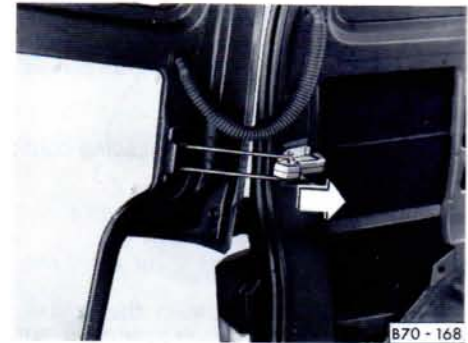

Unhooking door check strap

Both doors are held in the open position (approx. 90°) by check straps.

To open the doors further the check strap can be unhooked (see illustration). When doors are closed the check straps engage again automatically.

Windows

Mechanical windows

The windows are opened and closed with crank-handles fitted in the door trim panels.

Electric windows*

Electric windows offer the following comfort facilities:

- Single-touch opening for driver's and front passenger's door windows
- Single-touch closing of driver's door window

The windows function with the ignition switched on. If the driver's door is not opened after switching off the ignition, the windows can still be operated for about one hour. Apart from this, the windows can always function when the driver's door is open. For safety reasons, the single-touch closing of the driver's door window only functions when the ignition is on.

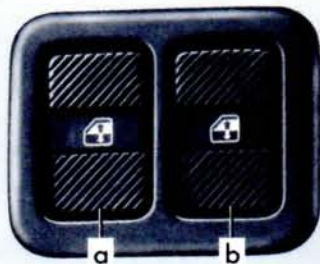

870 - 142

The switches are in the door trim panels.

The window of the front passenger's door can also be opened and closed from the driver's door.

- a - Driver's door
- b - Front passenger door

All windows can be **opened** automatically by touching the lower part of the appropriate switch. If more than one window is to be opened at the same time, this is done automatically, one after the other, in the selected sequence.

If the appropriate switch is tapped once again, the window will stop immediately.

All windows can be **closed** by pressing the upper part of the appropriate switch. To close the driver's door window, when the ignition is switched on, it is sufficient to touch the switch. If the switch is touched again, the window stops moving immediately.

Attention

■ **Be careful when closing the windows!**

Careless or uncontrolled closing of the windows can cause injuries.

Therefore when leaving the vehicle, always take the ignition key with you. The electric windows are then only put out of action if the driver's door is opened and closed again. As soon as the driver's door is opened again, the windows can once again function.

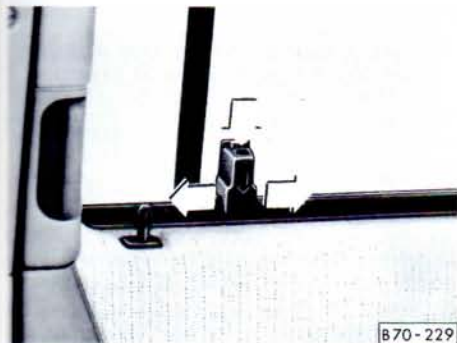

B70-229

Opening sliding window

Push the retaining catch down and slide window open.

Mirrors

Adjusting mirrors

The rear view mirrors should always be adjusted properly before moving off so that good vision to the rear is obtained.

Anti-dazzle inside mirror

The lever on the lower edge of the mirror should be pointing forwards when the basic setting is made.

To set the anti-dazzle position, pull lever to the rear.

Outside mirror

The outside mirror should be adjusted so that the side of your own vehicle can just be seen. This setting ensures the best possible field of view, and in addition it serves as an instant check on the mirror setting.

Normal outside mirrors are adjusted by pressing the edge of the mirror surface in the mirror housing.

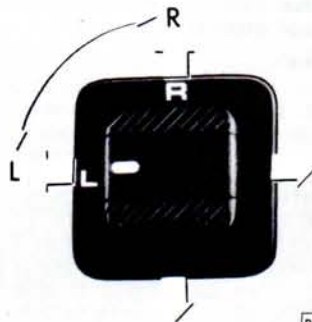

B70-176

Electrically adjustable mirrors* are set by moving the knob in the driver's door trim.

Turning the knob from L to R switches control from left to right mirror.

If the electrical control of the mirror fails at any time the mirrors can be adjusted manually by pressing on the edge of the mirror surface.

Note for vehicles with convex or aspherical outside mirrors *

Convex (curved outwards) mirrors enlarge the field of view but they make objects look smaller. These mirrors make it difficult to estimate how far away a following vehicle is.

Aspherical outer mirrors have a mirror surface with different curvature. This wide-angle mirror increases the area of vision even more so than conventional convex mirrors. Their usefulness is also limited when judging the distance to vehicles approaching from behind.



Folding outside mirrors in

The outside mirrors can be folded in. When folded in the mirrors are held by a detent. To fold out again, press mirror in towards vehicle, press detent in and fold mirror out – see illustration.

Mirror heating *

The electrically operated outside mirrors are heated as long as the heated rear window is switched on.

Attention
When folding mirror out ensure that the fingers are not trapped between mirror and bracket – Danger of injury.

Notes

- Before putting the vehicle through an automatic washing plant, the mirrors should be folded in to prevent them becoming damaged.
- These remarks apply only to vehicles with normal outside mirrors. Mirrors on extended arms can also be folded in but they have no detent.

Seat belts

It has been proven that seat belts give good protection in accidents. In most countries therefore the wearing of seat belts is required by law.

Attention

The belts should be put on before every journey – even in town traffic. This applies also to the rear seats.

Pregnant women too should always wear a seat belt.

The routing of the belt is of major importance to the protective effect of the belt. How the belt should be worn is described on the next pages.

How children can be carried safely in the vehicle is explained on page 18.

General notes

■ The belt must not be twisted.

■ Two persons (including children) must never be secured with **one** belt. It is particularly dangerous to put the belt round a child sitting on a persons lap.

■ The belt should not be worn over hard or breakable articles (glasses, ball pens, key rings, pipes, etc.) because this can cause injury to the body.

■ Loose, bulky clothing (e.g. overcoats over jackets) affects the fit and function of the belts.

■ The belt must not be jammed anywhere or rub on any sharp edges.

■ The lock tongue may only be inserted into the lock part belonging to the appropriate seat otherwise, the protective effect is impaired.

■ The slot for the belt tongue must not be blocked with paper or anything similar, otherwise the tongue cannot engage properly.

■ The belts must be kept clean otherwise the retractors may not work properly (see also "Care of car" section).

■ Seat belts which have become damaged or have been stressed in an accident and stretched must be renewed – preferably by a Volkswagen dealer. The anchorages should also be checked.

■ In some export countries seat belts could be used on which the functions differ from those described on the next pages.

■ On the Delivery Van there are no belt anchorage points in the load compartment.

Three-point inertia reel belts

The inertia reel belt gives complete freedom of movement when pulled slowly. Sudden braking however will cause the belt to lock.

The mechanism will also lock the belt when accelerating, driving down steep gradients or cornering.

Putting belt on

Pull the tongue slowly and smoothly across the chest and hips and push it into the lock part fitted on the seat until the tongue engages audibly (pull to check).



The shoulder part of belt must run roughly across the centre of the shoulder as shown – on no account against the neck – and be firmly in contact with the body.

The backrests of the front seats must not be inclined too far to the rear, otherwise the belts are no longer fully effective.



With the aid of the **belt height adjustment** the routing of the front seat shoulder belt can be set to fit the body properly.

- To adjust, push button with relay fitting (see right illustration) up or down so that the shoulder part of belt runs roughly across the centre of the shoulder as shown on the left – **on no account against the neck.**
- After adjusting, pull the belt with a jerk to ensure that the relay fitting is properly engaged.

The lap part of belt must always fit tightly across the pelvis. If necessary, pull the belt tight.

Particularly in the case of pregnant women, the lap part of the belt should be as low across the pelvis as possible so that no pressure is exerted on the abdomen.

Taking belt off

To release the belt, press the orange-coloured button in the lock. The tongue will then spring out.

Pass the tongue towards the door by hand so that the retractor can roll the belt up properly. A plastic knob in the belt holds the tongue in a convenient position.

Lap belt

The belt lock is used in the same way as on the three-point inertia reel belts.

The belt must always fit tightly across the pelvis.

For safety reasons a lap belt not being used should always be connected to the buckle.



833-497

To lengthen belt hold the tongue at right angles to belt and pull belt through to the required length – see illustration.

The belt is easier to adjust if tongue and cap are pressed together.

To shorten belt it is only necessary to pull the free end of belt.

The surplus belt length is taken up by moving the plastic slide.

Automatic retracting lap belts

The single seats* in the passenger compartment are equipped with an automatic retracting lap belt.

Putting belt on

Pull the belt out and insert the tongue into the appropriate lock part until tongue engages (pull to check).

The belt must always fit tightly across the pelvis, if necessary, pull the belt tight.

Note

If the belt is pulled too tight, it can be released by pressing in the button located on the belt reel.

Taking belt off

Press the orange-coloured button in the lock part and guide belt by hand so that the retractor can roll the belt up properly.

Safety for children

Children under 12 years of age should normally travel on the rear seat¹⁾(Caravelle, Kombi, Doublecab). Depending upon their age, height and weight, they must be protected with either a child restraint system or the seat belt provided.

A child may also occupy the front passenger seat if the restraint system used has been expressly approved for this purpose by the manufacturer. One should bear in mind however that they are generally safer on the rear seat.

On no account should children – or babies travel on an adult's lap.

■ Babies up to about 9 months old/10 kg are best protected, in an accident, with a safety seat or a special safety carrier.

■ Experience has shown that babies and small children up to about 3 years/18 kg are best protected in child seats or safety carriers where they can lie or sit facing the rear of the car.

■ Children up to about 7 years of age/25 kg, depending on their height, are safest when secured in a child seat or by a safety seat cushion.

■ Children over about 7 years of age may use the three point belts or two point belts provided on the rear seats. It is important to ensure that the diagonal part of the belt fits over the centre of the shoulder – and does **not make contact with the neck**. The lap part of the belt must pass across the pelvis and **not over the child's stomach**. If this is not so a safety cushion must be used to raise the seating position.

When using the belt the section "Seat belts" should also be noted.

Note the following points when purchasing, installing and using a child restraint system:

■ For safety reasons always use a restraint system which conforms to the international safety standard ECE R 44. Restraint systems that can be connected to the seat belts provided in the car are recommended.

■ Only use child seats or safety carriers of the type which have a large, flat area in contact with the car's seat upholstery. Child seats which have feet or tubular frames and no flat base can easily penetrate into the car's upholstery, and are therefore not so safe.

■ We recommend that child restraint systems from the genuine accessory programme of the Volkswagen dealers are used. Here under the name "Bobsy" restraint systems for all age groups are offered²⁾. These systems fulfil all the requirements mentioned and over and above this, have been developed and tested by us for use in Volkswagen vehicles.

■ Special care must be taken if child restraint systems are used which are bolted on at the same point as the belts provided in the vehicle. One must ensure that the bolt is long enough so that the full length of the threaded hole is utilized and tightened to a torque of 30 Nm

Furthermore, one should ensure that the belt itself cannot become damaged by sharp edged buckles etc.

■ For the installation and use, attention must be paid to the legal regulations and the instructions of the restraint system manufacturer.

²⁾ Not in all export markets

¹⁾ Observe any statutory regulations to the contrary.

Head restraints*



The front head restraints are adjustable for rake and height and should be set to suit the size of the person in the seat. Correctly adjusted head restraints together with the seat belts offer effective protection.

Adjusting height*

- Grip sides of head restraint with both hands and pull up or push down.
- The best protection is obtained when the upper edge of restraint is roughly at eye level.

Note

In vehicles with a high partition the head restraints are not adjustable.

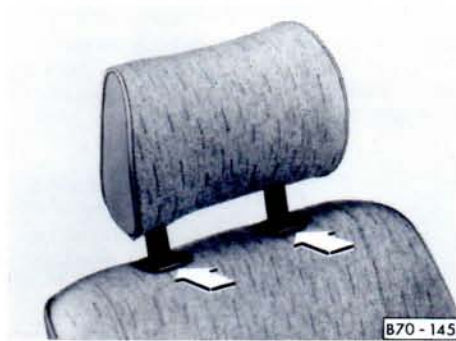

Removing and installing

To remove head restraints in front seat backrests, pull restraints up to the stop, press both buttons (arrows) and at the same time take restraints out.

To install again, push the restraint rods into the guides until they are heard to engage.

Note

On some models, head restraints are fitted which are retained by spring clips.

To remove the spring clips from the seat backrest guide rings, pull or push the clip out to one side with a small screwdriver.

When reinstalling, insert the head restraint first, and then push the spring clips in so that the straight leg is at the rear.

Seats in cab

The correct adjustment of the seats is important for:

- reaching the controls safely and quickly
- relaxed low-fatigue body position
- maximum protection from the seat belts.

The front seats should be adjusted before putting on the seat belt.

After every fore and aft adjustment of the seat check, by jerking with the body, that the retainers are properly engaged.



Driver and front passenger seats

To move seat backwards and forwards (1)

Lift lever and move seat. Then release lever and move seat further so that the catch engages.

The driver's seat should be adjusted so that the pedals can be fully depressed with the legs slightly angled.

Attention

For safety reasons the driver's seat must only be moved backwards or forwards when vehicle is stationary.



Adjusting backrest angle (2)

Take weight off backrest and turn knob.

The backrest of the driver's seat should be adjusted so that the top of the steering wheel can be reached with the arms angled slightly.

Attention

Do not lower the backrest too far when on the move because the seat belts are then no longer fully effective.

Seat stop (3)*

The second battery* is located under the left seat. To get to the battery the seat can be pushed forward past the normal stop:

- Push seat fully forward
- Pull stop outwards and push seat further forward.

Pivoting seats*

The release mechanism of both seats is located on each seat base at bottom right. Seats are released by pulling up the lever.

Both seats are turned anti-clockwise so that it might be necessary to push the seat forward slightly or open the doors.

Attention

When vehicle is moving the seats must be facing forward and be properly secured.

Two-seater passenger bench*

To lower the backrest, press locking knob to the rear.

When lowered, the backrest is locked. The locking knob must therefore be pressed again to lift backrest up.

Attention

For safety reasons the backrest must always be locked when vehicle is in motion.

Head restraints

The head restraints should be adjusted to body size – see page 19.

Seat heating*

Seat cushion and backrest of front seats can be heated electrically when ignition is on.

Further details are given under "Switches", page 51.

Armrests*

The armrests on the front seats can be hinged up if they are not required.

The angle of the armrests can be adjusted as required with a knurled knob, underneath the armrest.

Seats in passenger compartment



Centre seat and single seats*

Folding backrest down

To fold backrest down press the locking knob to the rear. When folded down the backrest is locked. To lift it up the locking knob must therefore be pressed again.

Attention

For safety reasons the backrest must always be vertical when vehicle is in motion.

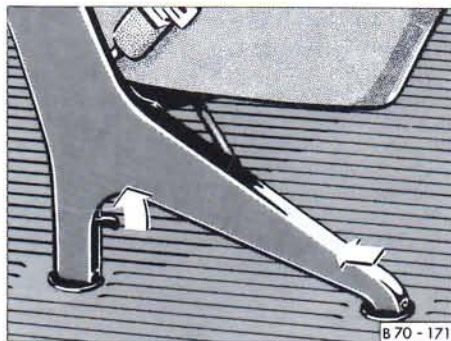

Removing seat

The seat can be removed easily.

- To remove pull levers on left and right of frame (illustration).
- Pull seat to rear slightly and take it out.

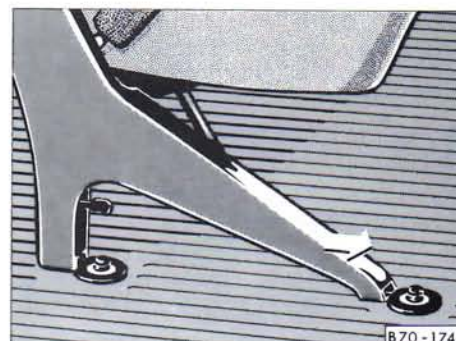

Installing seat

- To install, place seat in front of the securing parts in floor as shown.
- Lift levers on left and right of seat frame and push seat forward until it engages firmly in the securing parts.

Important notes on installing seats are given on the next page.

Attention

When installing the seats the following points are important for the safety of the vehicle occupants:

- The seats must always be firmly engaged in the mountings so that they cannot become detached when braking or in an accident.
- The seats must always be installed in the correct direction and position so that the belts provided for each place can be worn properly.



Attention!

When taking off the rear three point seat belts the belts must be pushed underneath the loops provided on the side trim panels. This will prevent the belts from becoming damaged when the rear seat backrest is folded forwards.



Tipping seat bench

- Fold backrest forwards
- Pull loop on lower part of seat bench
- Tip bench forwards.

Rear seat bench (three-seater)

To increase the size of the luggage area the rear seat, or the backrest only, can be tipped forward.

Folding backrest forwards

- Push lever at right or left of backrest forwards.
- Fold backrest down.



Removing rear seat

To increase the luggage/loading area, the rear seat can be removed:

- Fold backrest of centre seat forwards
- If fitted, fold folding seat* out of way – see page 25
- Remove lower seat frame trim* from rear seat
- Remove head restraints* – see page 19
- Fold backrest down – see page 23
- Tip seat forwards – see page 23
- Loosen and remove two bolts (arrows in the left illustration)
- Carefully fold seat back



- Fold back carpet* to attain access to the front bolts
- Loosen and remove front bolts (arrows in the right illustration)
- Remove seat to rear
- Screw in and tighten all four bolts in the securing points.

Fitting rear seat

- Fold down backrest of centre bench seat
- If fitted, fold folding seat out of way.
- Fold back carpet and retain with something heavy
- Remove the four bolts

- Fit seat into position
- Tighten front bolts by hand (right illustration)
- Carefully fold seat back
- Insert rear bolts (left illustration) and tighten all four bolts

Attention

Ensure that that the rear seat bench securing bolts are tightened again, as the security of the seat belts and therefore the safety of the passengers depends upon it.

- Fold backrest up

Notes

- It is expedient for two people to carry out the removal and fitting of the rear bench seat.
- When removing and fitting the seat ensure that the belts, side trim, loudspeaker grilles etc. are not damaged or soiled.

Folding seat*



The single seat next to the centre seat bench can be folded, in such a manner, to enable easy access to the rear seat bench.

Folding seat

- Unlatch the seat backrest and tip backrest forwards (left hand illustration).
- Then, tip the seat sideways to the left (centre and right hand illustrations).



- To return the seat to its original position proceed in the reverse order.

Removing seat

The seat can be removed by performing a few simple operations).

- Set seat into sitting position.
- Press both levers on foot part of seat downwards.
- Press seat towards left hand side in direction of seat bench and take out.

Installing seat

- To install the seat, place seat on left hand side (as viewed from driving direction) next to the securing elements on vehicle floor.



- Then, pull seat towards right, until seat engages firmly in the securing parts.

Attention

- **The seat must always be properly engaged in the retainers to ensure that it cannot move if the brakes are applied or the vehicle is involved in an accident**
- **The seat must always be reinstalled in the correct direction and position. This ensures that the seat belt provided can always be properly used.**

CONTROLS AND EQUIPMENT

Loading/sleeping surface*



The rear seat backrest with a loading/sleeping surface can be folded forward to provide a large loading and/or sleeping surface.

- Remove head restraints from rear seat bench.
- Unlatch the backrest at the left or right hand outer side and tip it forwards (left hand illustration).



- Unlatch the centre seat bench backrest, fold it forwards and fold the wooden part forwards until a large surface is provided (centre illustration).
- To return the backrest to its original position proceed in the reverse order.



Attention
When the vehicle is moving, no one, and this includes children, may remain on the loading/sleeping surface.

Further important instructions on loading are to be found on page 28.

Luggage compartment cover*

On vehicles with a rear seat bench, a luggage compartment cover can be installed, depending on the vehicle version.

When loading, the luggage compartment cover can be tipped upwards.

Attention

When the vehicle is moving no persons, animals or heavy items of luggage are to be carried on the luggage compartment cover – danger of injury when brakes are applied suddenly or when vehicle is involved in an accident.

Further important instructions on loading are to be found on page 28.

Luggage compartment/load surface

To enlarge luggage space

Lower backrest and seat as described on page 23.

Notes on loading

In the interests of good handling ensure that the load (persons and luggage) is distributed evenly. Heavy items should always be carried as near to the rear axle as possible or better still, between the axles.

The permissible axle and gross weights must not be exceeded under any circumstances.

Attention

■ It should be noted that when transporting heavy items the handling will change due to the displacement of the centre of gravity. Driving style and speed must be altered to suit.

■ The load must be stowed so that no items of luggage can fly forward if brakes are applied suddenly. – If necessary use the lashing eyes.

■ One should ensure that the heater elements in the rear window on the Variant are not damaged by articles rubbing against them.

■ The stale air escapes through ventilation openings at the rear. The function of these openings must not be impaired.

Attention

■ When vehicle is on the move no persons may be in the luggage compartment. This includes children. Every passenger must be belted in properly – see page 15.

■ Never drive with the tailgate or wing doors not properly closed otherwise exhaust gas can be drawn into the vehicle interior.



Lashing eyes*

On vehicles with lashing eyes the load should always be secured to the eyes.

Each eye has a tensile strength of 500 kg.

Pedals

The movement of the pedals must not be restricted.

For this reason, do not put articles in the footwell which could roll or slide underneath the pedals.

Around the pedal area there should not be any foot mats or other additional floor covering materials:

- In the case of defects on the brake system, a greater pedal travel may be necessary.
- It should always be possible to depress the clutch and accelerator pedals fully.
- All pedals must be able to return, unhindered, to their rest positions. Therefore, the only foot mats which may be used are those which leave the pedal area completely free and which are prevented from slipping.

Brakes

The following points are of particular importance to the safe operation of the brakes.

- New brake linings must also be run in and do not have the optimum friction properties during the first 200 km. The slightly reduced braking effect can be compensated for by more pressure on the brake pedal. This also applies when new linings have been fitted.
- If the brake pedal travel increases suddenly, it may be that one of the two brake circuits has failed. You can still drive on to the next Volkswagen dealer but be prepared to use more pressure on the pedal and allow for longer braking distances on the way.
- The brake fluid level must be checked regularly—see page 105. The brake warning lamp will come on to indicate that the brake fluid level is too low (see also page 48).
- Brake lining wear depends to a large extent on the operating conditions and style of driving. On vehicles which are used mainly in town traffic and stop/start conditions or are driven hard it may be necessary to have the thickness of the brake linings checked by a Volkswagen dealer in between the intervals given in the Service Schedule.
- Change down in good time when driving downhill, in order to make use of the engine braking effect. This relieves strain on the brake system. When the brakes are applied

do not keep them on continuously, apply and release alternately.

■ Under certain operating conditions, for example after driving through water, after heavy rain or after washing the vehicle the braking effect may be retarded by wet, or in winter iced-up brake discs and linings – the brakes must be dried out first by applying the footbrake.

The full braking effect may also be delayed when vehicle has been driven for some time on heavily salted roads without using the brakes, because the layer of salt on discs and pads has to be removed first.

Attention

If a front spoiler, full size wheel trims etc., is retrofitted, it is necessary to ensure that the flow of air to the front brakes is not restricted – otherwise the brakes can overheat.

Brake servo

Attention

The servo is operated by vacuum which is only generated when engine is running. For this reason the vehicle should not be allowed to roll with the engine switched off.

When the brake servo is not working because, for example, the vehicle is being towed or because a defect has occurred on the brake servo itself, the brake pedal must be pressed considerably harder to compensate for the absence of servo assistance.

Anti-locking brake system *

The ABS plays a major part in increasing the active safety of the vehicle. The big advantage when compared with a conventional brake system is that even when braking hard on a slippery road surface the best possible steerability is retained for the road condition because the wheels do not lock.

However, one must not expect the ABS system to shorten the braking distance in all conditions. When driving on gravel or on fresh snow covering a slippery surface, i.e. when one should be driving very carefully in any case, the stopping distance may even be slightly longer.

How the ABS system works

When the turning speed of a wheel reaches a level which is too low for the vehicle speed and it tends to lock, the brake pressure to this wheel is reduced. On the front axle the brake pressure is regulated for each wheel individually, whereas on the rear axle, the pressure is regulated for both wheels at the same time. As a result the braking effect is the same for both rear wheels and the driving stability is retained as far as possible. This regulating process makes itself known by movement of the brake pedal and is accompanied by noises. This is done deliberately as a warning to the driver that a wheel or the wheels are in the locking range. So that the ABS can regulate effectively in this range the brake pedal must remain de-

pressed – on no account should it be pumped!

Attention

However the ABS system cannot overcome the physical limits. This must be borne in mind particularly on slippery or wet roads. When the ABS comes into the control range the speed must immediately be adapted to the road and traffic conditions. The increased amount of safety available must not tempt one into taking risks.

If a defect occurs on the ABS it is indicated by a warning lamp – see page 49.

Manual gearbox

Handbrake

To apply the handbrake pull lever up firmly. On hills the 1st gear or with automatic gearbox the parking lock should also be engaged. The handbrake should always be applied so firmly that it is not possible to drive inadvertently with the handbrake on.

When handbrake is applied with the ignition on, the brake warning lamp comes on.

To release handbrake, pull lever up slightly, press locking knob in and push lever right down.

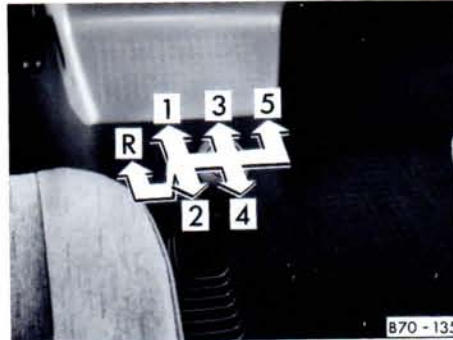

Gear gate

- All forward gears are baulk synchronised. The synchronising hubs enable easy noise-free selection of the forward gears.
 - Only engage reverse gear when vehicle is stationary. When engine is running, depress clutch fully and wait a few seconds before moving gear lever, to prevent grating noises.
- When reverse gear is engaged with ignition on, the reversing lights come on.

Note

When driving you should not rest your hand on the gear lever. The pressure of your hand is transmitted to the selector forks in the gearbox and can cause premature wear on the forks.

Automatic gearbox*



The vehicle is equipped with an electronically controlled 4-speed automatic gearbox.

The gearbox has a lock-up clutch which eliminates the system-inherent converter slip in 4th gear, and in certain driving conditions also in 3rd gear. This significantly improves the efficiency of the gearbox in these two gears and reduces the fuel consumption.

Depending on driving style the lock-up clutch can cause more frequent gear shifting. This is normal and no cause for concern.

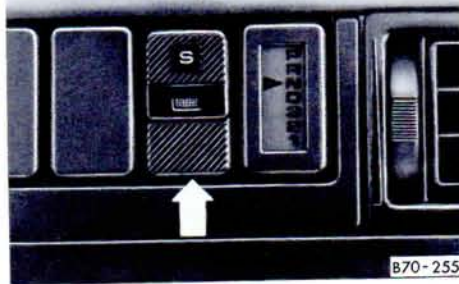

Programme switch

The programme switch in the instrument panel can be used to select a sports programme for a sporty type of driving (**S** – warning lamp lights up) or for normal driving (warning lamp out).

The programme selection can be made by pressing the switch (arrow) when vehicle is stationary or on the move.

Normal driving

The programme by changing up early and changing down late, makes economical driving possible.

S – Sport programme

For a sporty style of driving, this programme should be selected. By changing up later full use can be made of the engine's power reserve. Changing down is effected at higher engine speeds than in the normal driving range.

Note

The programme which has been selected remains engaged even after the engine has been switched off. This means that a change of programme can only be effected by operating the switch.

Emergency programme

If functional defects occur in the electronic system the gearbox can, amongst other things, carry on operating in two emergency programmes:

- The gearbox continues to change up and down automatically as before but hard shift jerks are however noticeable. The vehicle should be taken to a Volkswagen dealer.

- The gearbox no longer changes up and down automatically.

The gearbox can then be shifted manually but in the selector lever positions "D", "3" and "2" only the 3rd gear is available.

In selector lever positions "1" and "R", the 1st and reverse gears are available as normal.

However, the converter must, due to the absence of 2nd gear work harder, and under certain circumstances this causes the converter to overheat. In a case such as this the vehicle should be taken, as soon as possible, to a Volkswagen dealer.

Selector lever lock

In positions "P" and "N" with the ignition switch on the selector lever is locked. To move the selector lever out of these positions the brake pedal must be depressed and the selector lever button pushed-in. This prevents a gear being engaged inadvertently and the vehicle unintentionally moving off.

A delay circuit prevents the selector lever from locking when it is moved quickly past the "N" position (for instance from "R" to "D"). This enables for example the vehicle to be "rocked" out of a "bogged down" position. The shift lock only locks the selector lever if it is left in the "N" position for more than about 1 second without the brake pedal being depressed.

At speeds above 5 km/h the selector lever lock is automatically switched-off in position "N".

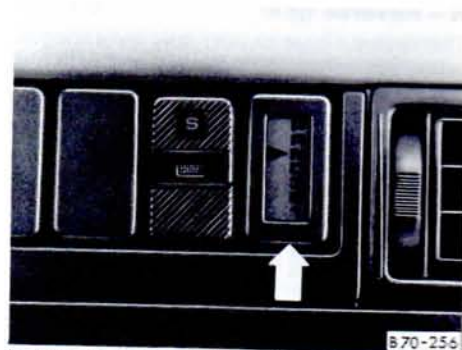

In the dash panel there is a display¹⁾ that shows the currently selected selector lever position.

Selector lever positions

P - Parking lock

The driving wheels are locked mechanically.

The parking lock may only be engaged when the vehicle is stationary. Before moving the lever in or out of the "P" position the lock button in the selector lever handle must be pressed. Before moving the selector lever out of the "P" position, the brake pedal must also be depressed when the ignition is switched on.

¹⁾ Depending upon the model the display can also be fitted in the Combi-instrument.

R – Reverse gear

The reverse gear should only be engaged when the vehicle is stationary and with the engine idling. Before engaging the position "R" from the positions "P" or "N" the brake pedal must be depressed and the lock button in the selector lever handle must also be pressed.

The reversing lights come on then the selector lever is in the "R" position with the ignition switched on.

N – Neutral (idling position)

To move the lever out of neutral when stationary or at speeds below 5 km/h and with ignition switched on depress the brake pedal and press the lock button in the selector lever handle.

D – Normal driving position

The four forward gears are shifted up and down automatically depending upon throttle opening and programme selected.

Under certain driving conditions it is advantageous to engage one of the following described selector lever positions.

3 – Position for hilly regions

The 1st, 2nd and 3rd gears are shifted up and down depending upon engine load, road speed and programme selected. The 4th gear is not engaged. This increases the engine braking effect when the accelerator pedal is released.

This selector position is recommended in situations where the gearbox alternates frequently between 3rd and 4th gears in the "D" position.

2 – Position for steep hills

This selector lever position is suitable for long climbs and descents.

The 1st and 2nd gears are shifted up and down automatically depending on engine load, road speed and programme selected. To prevent unnecessary changing up 3rd and 4th gears are not engaged. This further increases the engine braking effect on deceleration.

1 – Position for very steep hills

This selector lever position is recommended for very steep climbs and descents.

To engage this gear, the lock button in the selector lever handle must be pressed in. The vehicle only moves in 1st gear. The 2nd, 3rd and 4th gears are not engaged. Maximum possible engine braking effect is now available.

The cruise control * cannot be used in position "1".

Note

When changing down manually the selector lever can be moved into the positions "3", "2" and "1", but the gearbox will not change down until it is no longer possible to over-rev the engine.

Kick-down device

The kick-down device gives maximum acceleration. When the accelerator pedal is pressed right down past the full throttle position, depending on road speed and engine speed, the box changes down into a lower gear. The upshift into the next higher gear then takes place as soon as the maximum specified engine speed is reached.

Notes on driving

Starting

The engine can only be started when selector lever is at "N" or "P". See also "Starting engine" on page 37.

Selecting a driving range

When the vehicle is stationary and the engine is running always depress the foot brake when selecting a gear.

When the vehicle is stationary do not depress the accelerator when selecting a gear.

If the lever is moved accidentally into "N" when driving, release accelerator and let the engine speed drop to idling before selecting a forward gear again.

■ Attention

■ When the engine is running it is necessary to hold the vehicle with the foot brake in all gears. Because with an automatic gearbox the transfer of power is not fully interrupted even at idling speed – and the vehicle tends to "creep".

When the vehicle is stationary and a gear is engaged, the throttle must not be opened inadvertently on any account (for instance by hand from the engine compartment). Otherwise the vehicle will move immediately – even if the handbrake has been fully applied.

Before working on the vehicle with the engine running, apply the handbrake and put the selector lever in "P".

Moving off

Select driving range (R, D, 3, 2, 1). Wait until the gearbox has shifted and the power flow is made to the driving wheels (light selection jerk perceptible). Then one can accelerate.

Stopping

To stop vehicle temporarily such as at traffic lights, it is only necessary to apply the brakes. It is not necessary to move selector lever to "N". The engine should however only be running at idling speed.

Parking

On level ground all you need do is engage the parking lock. On a gradient the handbrake should be applied firmly first and then the parking lock engaged. This will ensure that the locking mechanism is not too heavily loaded and makes the lock easier to disengage.

Tow starting

On vehicles with automatic gearbox the engine cannot be started by towing or pushing the vehicle. See page 133.

When the battery is flat, the engine can be started from the battery of another vehicle by using jumper cables. See "Emergency starting", page 130.

Towing

If the vehicle has to be towed at any time, you must read the instructions in the section "Towing/tow starting on page 132.

Ignition lock

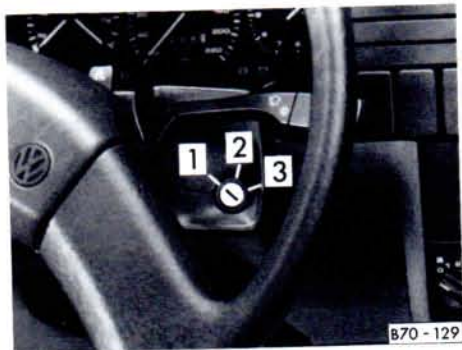

Petrol engines

- 1 - Ignition off/engine stationary
- Steering can be locked
- 2 - Ignition on
- 3 - Starting engine

Diesel engines

- 1 - Fuel supply cut off/engine stationary - Steering can be locked
- 2 - Glow and drive position
No other current consumers should be switched on together with the glow plugs - this avoids draining the battery unnecessarily.
- 3 - Starting engine

For all vehicles:

Position 1:

To **lock the steering wheel** withdraw key and turn wheel until you hear the locking pin engage.

Attention

Do not withdraw key from lock until vehicle is stationary! The steering lock could be unintentionally engaged.

Position 2:

If the key is difficult to turn in the lock or cannot be turned to this position at all, the steering wheel must be rocked to and fro slightly to release the locking pin.

Position 3:

In this position the headlights and other heavy current consumers are switched off.

Before the starter can be operated again the key must be turned back to position 1. The non-repeat mechanism in the ignition lock prevents the starter from being operated when engine is running, as this could damage the starter.

Starting the engine

General hints

Attention

When starting the engine in confined spaces there is a danger of poisoning.

■ Before starting, move gear lever to neutral (with automatic gearbox, selector lever in "P" or "N" position) and apply handbrake firmly.

■ On vehicles with a manual gearbox depress the clutch pedal when operating starter so that starter only has to turn engine.

■ As soon as engine starts, release the ignition key so that starter can disengage.

■ After starting a cold engine it may sound noisy for a moment or two because the oil pressure has to build up in the hydraulic tappets first. This is normal and no cause for alarm.

 **Do not warm engine up by running it with vehicle stationary. Drive off straight away.**

Do not overrev or use full throttle until the engine has reached the normal operating temperature.

■ **On vehicles with a catalytic converter the engine must not be started by towing the vehicle in excess of 50 m. Otherwise unburnt fuel can pass into the converter and lead to damage.**

■ **Before trying to start engine by towing, the battery from another vehicle should be used for starting if possible – see page 130.**

Petrol engines

These engines are equipped with a petrol injection system that automatically supplies the correct fuel/air mixture at all ambient temperatures.

When engine **is cold or at operating temperature** do **not** accelerate before or during the starting procedure.

Applicable to all engines:

If the engine does not start at once, stop using the starter after 10 secs. wait about half a minute and then try again.

If the engine still does not start, the electric fuel pump fuse may have blown – see page 122.

When the engine **is very hot** it may be necessary to accelerate slightly after the engine has started.

Diesel engines

Glow plug system

The engine is fitted with a glow plug system. The required glow plug warm-up time is indicated by a lamp which is controlled by the coolant temperature – see page 49.

Cold starting aid

To assist cold starting, there is a device (cold starting aid) fitted in the injection pump.

The cold starting aid is actuated when the knob on the left of the steering column is fully pulled out.

Starting a cold engine

■ At ambient temperatures down to **-15 degrees C**, pull the cold start knob out **fully** before operating the starter.

At lower temperatures, the knob should not be pulled out **until engine is firing regularly** – the engine will then start more readily.

■ Turn the key in the ignition lock to position 2 (see page 36) – the glow plug warning lamp comes on. It goes out when the ignition temperature is reached (see page 49).

While the glow plugs are working do not switch on any other heavy current consumers because this would place an unnecessary load on the battery.

■ When the warning lamp goes out, start the engine immediately. Do not depress the accelerator while starting.

If the engine only fires irregularly, continue to operate the starter a few seconds longer (30 seconds at maximum) until the engine runs under its own power.

If the engine does not start, switch the glow plugs on again and try starting it again as described. If the engine still does not start the fuse for the glow plugs may have blown – page 123.

■ Push the cold start aid knob in fully as soon as the engine has reached its normal operating temperature.

Starting a warm engine

The glow plug lamp does not come on – the engine can be started straight away. Do not pull the cold start aid knob and do not press the accelerator pedal.

Stopping engine

■ Applies to all engines:

When engine has been running fast for a long time, let it idle for about 2 minutes so that it can cool down slightly before being switched off.

Attention

After the engine has been stopped the fan can continue running for a while (up to about 10 minutes) with the ignition switched off. It can also start to run again suddenly after a short time if

- the coolant temperature increases due to heat build-up
- when engine is hot and the engine compartment is heated additionally by strong sunlight.

Special care must therefore be taken when working in the engine compartment.

■ Applicable to vehicles with catalytic converter *:

The ignition must not be switched off as long as the vehicle is rolling with a gear engaged, otherwise, unburnt fuel can pass into the catalytic converter and cause damage.

Instruments



The arrangement of the instruments depends on the model concerned and the engine fitted.

1- Speedometer	40
2- Coolant temperature	41
3- Digital clock*	41
or multi-function indicator*	42
4- Fuel gauge	46
5- Rev counter*	46
or analog clock	46

1 - Speedometer

During the running-in period the instructions on page 76 should be noted.

Mileage recorder

The upper counter registers the total distance driven and the lower one the short trips.

The last figure of the lower counter indicates 100 m or $\frac{1}{10}$ mile.

The trip recorder can be set back to zero by pressing the knob in the speedometer dial.



2 - Coolant temperature



The gauge starts to work when ignition is switched on, but it takes some time before the needle reaches its final position.

When ignition is switched on the warning lamp flashes for a few seconds as a functional check.

a - Cold

Avoid high engine speeds and do not work engine too hard yet.

b - Normal

When the vehicle is driven normally the needle should settle down in this zone.

When engine is working hard and the ambient temperature is high, the needle may

This is not serious as long as the warning lamp does not flash.

Warning lamp

If the lamp flashes when driving, check first the indicated coolant temperature.

If the needle is in the normal zone, top the coolant up at the next opportunity.

If the reading is in the upper zone, either the coolant level is too low or the coolant temperature is too high. **Stop, switch engine off** and try to find cause of trouble – see page 47.

Notes

■ **Additional lights in front of the cooling air intake interfere with the flow of cooling air. At high ambient temperatures and full throttle there is a danger that the engine will then overheat.**

3 - Digital clock *

To set the time there are two buttons on lower left of instrument cluster. The hours are set with the upper button (h) and the minutes with the lower one (min):

■ If pressed briefly, preferably with a ball pen, the time changes one hour or one minute.

■ If pressed continuously the hours or minutes change continuously. With the minute button the clock can be set exactly to the second:

■ Press button until time shown by clock is one minute before time to be set.

■ Press button at the moment when the seconds indicator of an accurate clock shows a full minute or when the time signal is heard on the radio.



3 - Multi function indicator *

In addition to the time display, the multi-function indicator (MFI) gives a whole range of additional information:

- Driving time
- Average fuel consumption
- Distance driven
- Average speed
- Engine oil temperature
- Ambient temperature

With the exception of the time, the symbol for the function switched on appears at the upper edge of the display (in illustration the average fuel consumption is shown).

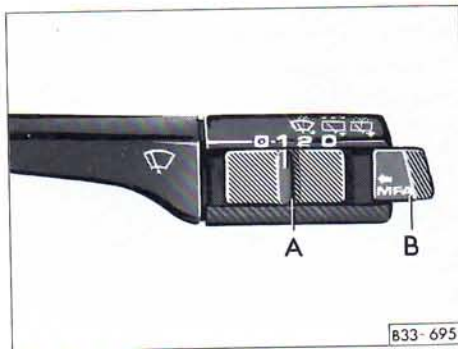

By repeatedly pressing button B in the windscreen wiper lever with the ignition switched on, the additional information is displayed, starting with the time.

If the button B is pressed for longer than 1 sec., the function being displayed at that time will change over automatically to the time display.

The memories

The system is equipped with two automatic memories:

A single journey memory collects the following data from the time the ignition is switched on to when it is switched off. Driving time, distance covered and fuel used. From this data the average driving speed and the average consumption is worked out.

If the journey is resumed within two hours of switching off the ignition, the new figures are automatically included in the calculation. If the journey is interrupted for more than two hours, the stored information is automatically erased.

A total journey memory stores the data from any number of individual journeys up to a total of 100 hours driving time, a distance of 10000 km (6214 miles) and 1000 litres (220 gallons) of fuel consumed. This data is only used to work out the consumption and speed averages for all the individual journeys.

If one of the given figures is exceeded, the memory is erased and calculation starts from the beginning again. Contrary to the single journey memory, this memory is not erased after a journey pause of more than two hours.

To **call up** the data the memories are selected by means of the switch A in the wiper lever:

- 1 – Single journey memory
- 2 – Total journey memory

The following data can be obtained from the memories:

- Driving time
- Average fuel consumption
- Distance driven
- Average speed

Erasing the memories

With the ignition switched on, both memories can be erased separately in each switch position by pressing switch A passed the appropriate detent position to 0 position for longer than one second.

If the battery is disconnected for any reason, the stored information is automatically erased.

The displays

When the ignition is switched on "MFI 1" or "MFI 2" appears in the display according to which memory is switched on.

No symbol – Time

The time is shown even when the ignition is switched off.

The time can be set with the buttons (h and min) on the lower left of instrument cluster – see "Digital Clock" page 41.



– Driving time

In switch position 1 the driving time which has elapsed since ignition was switched on or the memory cancelled is indicated – see previous page also "Single journey memory".

In switch position 2 the total driving time for all individual journeys is indicated – see previous page also "Total journey memory".

The maximum time in both switch positions is 99 hours 59 minutes. When this figure is exceeded the indication starts at zero again.

MPG (l/100 km) – Average fuel consumption

The average consumption is indicated not the actual consumption at the time of reading.

The average fuel consumption is indicated, after switching on the ignition or erasing the memory being used, after a distance of about 100 metres. Up to this point a dash appears instead of a figure. When vehicle is moving the indicated value is up-dated every 5 seconds.

In switch position 1 the average consumption for the single journey is indicated.

In switch position 2 the average consumption indicated is that obtained during all single journeys – see "Total journey memory" on previous page also.

Note

The amount of fuel used is not indicated.

Miles (km) – Distance covered

The remarks made under "Driving time" also apply in principle to "Distance covered". The maximum distance indicated is 9999 km or 6214 miles.

MPH (km/h) – Average speed

The remarks made under "Average fuel consumption" also apply here in principle.

°C – Engine oil temperature

Oil temperatures (within a range of + 50 degrees C and + 160 degrees C) are shown. When no oil temperature indication is shown, the engine is still not warm, and it should not therefore be worked hard. The engine speed should be reduced if the oil temperature rises to + 145 degrees C.

°C – Ambient temperature

The measuring range is from – 40 degrees C to + 50 degrees C..

When the vehicle is stationary or only moving very slowly, the indicated temperature could be slightly higher than the actual ambient temperature due to heat radiation from the engine or use of the auxiliary heater.

Attention

If the ambient temperature reading is used as an ice warning, remember that ice can form on the road at temperatures above 0 °C.

Note

Both temperatures are momentary values. They are not stored in the memory.

Tachograph*

In many European countries the installation and use of a tachograph is obligatory for the following vehicles:

- 1- Vehicles used for the commercial transport of goods with a permissible total weight including trailer or articulated trailer of more than 3.5 tons. It is immaterial whether the vehicle and the trailer or only one of the two is used for commercial goods transport.
- 2- Vehicles which according to their design and equipment are suitable for and intended to carry more than 9 persons including the driver.

Details of the regulations can be obtained from local vehicle licensing authorities.

The operation of the tachograph is described in a special leaflet from the tachograph manufacturers.



4 – Fuel gauge



This gauge works when ignition is switched on but it takes some time for the needle to reach its final position.

The tank holds about 80 litres.

When the needle reaches the start of the reserve zone (arrow) there is about 10 litres (2 gallons) of fuel left in the tank.

5 – Analog clock

To set the time press the button on lower right in combi instrument:

- If pressed briefly, preferably with a ball pen, the time is advanced one minute.
 - If pressed continuously the minute hand goes faster and at the same time the hours are set as well.
- With the button the clock can be set exactly to the second:

- Press button until time is one minute before time to be set.
- Press button at the moment when the seconds indicator of an accurate clock shows a full minute or when the time signal is heard on the radio.

5 – Rev counter *

The rev counter needle must not move into the red zone of the scale on any account.

The additional red dotted zone before the red zone on the scale which some models have shows the maximum engine speed permitted briefly e.g. when overtaking when engine has been run in and is warm – see page 76 also. It is advisable to change up or reduce engine speed at the latest by the time the needle reaches this zone..

 **Changing up in good time helps to save fuel and keeps the noise down.**

Change down to the next lower gear before the engine no longer runs smoothly.

The green or green shaded area on the scale shows the speed at which the engine is developing its most favourable torque and is working most economically. Drive as often as possible with needle in this area.

During the running-in period, high engine revs should be avoided.

Warning lamps



The layout of the warning lamps depends on the model and the engine fitted. The symbols shown here are also on the actual warning lamps.

- 1- Coolant temperature/ coolant level 47
- 2- Engine oil pressure 47
- 3- High beams 48
- 4- Turn signals 48
- 5- Brake system 48
- 6- Alternator 49
- 7- Glow plugs 49

1 - Coolant temperature/ Coolant level¹⁾



This lamp flashes for a few seconds as a functional check when ignition is switched on.

If the lamp does not go out afterwards or flashes when driving, either the coolant temperature is too high or the coolant level¹⁾ too low:

Stop, switch engine off and check level. Add coolant if necessary.

¹⁾ Only on vehicles with automatic coolant level monitor (see page 102).

Attention

- Be careful when opening the coolant expansion tank! When the engine is hot the cooling system is under pressure - Danger of scalding! Therefore let engine cool down before unscrewing the cap.
- Do not touch the fan. The fan can switch on suddenly - even when ignition is switched off.

For further details see pages 102 and 103.

If the coolant level is in order the trouble may be due to failure of the radiator fan. Check radiator fan fuse and renew if necessary - see page 122.

If the warning lamp does not go out although coolant level and fan fuse are in order, **do not drive on** - call in expert assistance.

If the trouble is only caused by the fan and assuming coolant level is in order and temperature warning lamp is out - one can drive on to the nearest Volkswagen dealer. In order to make good use of the air stream for cooling, do not let engine idle or drive very slowly.

2 - Engine oil pressure



The warning lamp flashes when ignition is switched on, the lamp must go out when engine has started.

If the warning lamp does not go out or flashes when driving – a buzzer also sounds at engine speeds above 2000 rpm – **stop, switch engine off**, check oil level and if necessary, add oil – see page 97.

If the lamp comes on although the oil level is in order, **do not drive on**. Do not even run the engine at idling speed – call in expert assistance.

Note

The oil pressure warning lamp is not an oil level indicator. The oil level should therefore be checked at regular intervals, preferably every time the fuel tank is filled.

3 – High beams



The warning lamp comes on when high beams are on or when the headlight flasher is used.

4 – Turn signals



The warning lamp flashes when turn signals are switched on. If a turn signal fails, the warning lamp flashes twice as fast. (Not when towing a trailer).

Further details are given on pages 49 and 52.

5 – Brake system



The warning lamp comes on when

- the handbrake is on
 - the brake fluid level is too low
- The ignition must be switched on.

Attention

If the lamp does not go out when handbrake is released or comes on when driving, the fluid level in the reservoir is too low. If an increase in pedal free travel is noticed at the same time, one of the brake circuits may have failed.

You can drive on carefully to the nearest Volkswagen dealer but allow for higher pedal pressures and longer braking distances on the way.

6 – Alternator



The warning lamp comes on when the ignition is switched on and must go out when the engine is started.

If the warning lamp comes on when driving, **stop, switch engine off** and check the alternator V-belt.

If the V-belt is broken or loose do not **drive on** with a vehicle which has a **4 cylinder engine** because the coolant pump is then no longer being driven. The V-belt must be tensioned or renewed.

Vehicles with a 5 cylinder engine can normally be driven to the nearest Volkswagen dealer when the V-belt is broken or loose because the coolant pump is driven separately but then the battery will discharge continuously and all non-essential electrical consumers should be switched off.

If the warning lamp comes on although the belt is not broken, one can normally drive on to the nearest Volkswagen dealer (all engine types) but the battery will then discharge continuously – see previous paragraph.

7 – Glow plugs



(Diesel engines only)

When the engine is **cold** the warning lamp comes on when key is turned to Drive position (ignition on).

If the warning lamp does not come on, there is a defect in the glow plug system – call in expert assistance.

When the lamp goes out, start the engine immediately – see page 38.

When the engine is **warm** the glow plug lamp does **not** come on – the engine can be started straight away.

(ABS) – Anti-locking Brake System (ABS)*

The operational readiness of the essential electrical components of the ABS are checked, both before moving off and when driving, by an electronic monitoring system.

The warning lamp lights up when the ignition is switched on and it must go out again, at the latest, after the engine has started.

If the warning lamp does not go out or if it comes on when driving the system is not in order. The vehicle can then only be braked with the normal system – that is without ABS –. The vehicle must be taken to a Volkswagen Dealership as soon as possible.

Further details on ABS is given on page 30.

◊1◊ – Trailer turn signals

The warning lamp * flashes when turn signals are switched on when towing a trailer.

If a turn signal fails on the trailer or vehicle, the warning lamp does not flash.

Switches



Notes

- On vehicles with righthand drive the arrangement of the switches differs. The symbols on the switches are however the same as on vehicles with lefthand drive.
- The use of the lighting described here is subject to local regulations.

1 - Lighting switch



- First detent –side lights¹⁾
- Second detent –headlight high/low beams

The headlights only work when the ignition is on. When the engine is being started and after ignition has been switched off, the headlights are switched off automatically.

When the side lights are on, a warning lamp lights up in the switch.

When the lights are on, the level of the instrument lighting can be regulated by turning the knurled disc on the right of the switch.

Dipping and flashing the headlights – see page 52.

2 - Headlight range control *

With the electrical range control the headlight settings can be matched exactly to the load condition of vehicle. This prevents oncoming traffic from being dazzled more than is unavoidable. At the same time the correct headlight beam setting provides the best possible visibility for the driver.

The headlights can only be regulated with the dipped headlights switched on.

To lower the beams, turn knurled disc from the basic position (–) downwards.

Note

The basic headlight setting (only possible with headlight adjusting appliance) must always be done with the headlight headlight range control knurled disc in the basic position (–) – see page 128 also.

¹⁾ On vehicles for some export countries when the side lights are switched on with the ignition switched on, the dipped headlights come on with reduced intensity.

3 - Emergency lights



When the emergency lights are on, a warning lamp in the switch flashes as well.

The system also works when the ignition is switched off.

4 - Knurled wheel for seat heating*



The cushion and backrest of the front seats can be heated electrically when the ignition is on.

The heating is switched on and regulated with the knurled wheel.

To switch heating off, turn knurled wheel to the left to the detent position.

5 - Heated rear window



The heating works only when ignition is on. When heater is on a lamp in the switch lights up.

As soon as window is clear, switch element off. The reduced current consumption helps to reduce the fuel consumption - see also page 80.

On vehicles with electrically adjustable exterior mirrors the mirrors are heated as long as the rear window heating is switched on.

6 - Fog lights */ Rear fog light



First detent - fog lights

Second - front **and** rear fog
detent lights, or rear fog light
only

At the second position a warning lamp in the switch comes on.

The **fog lights** work with the side lights (ignition on), low or high beams.

The **rear fog light** works only with the fog lights or with the low or high beams.

Due to the amount of dazzle it causes the rear fog light should only be switched on when the visibility is very poor (in Germany for example, below 50 metres).

Note

The electrical system of the factory fitted tow bar* is wired-up so that when towing a trailer fitted with rear fog lights, the rear fog light on the towing vehicle are automatically switched off.

Turn signal and dip lever

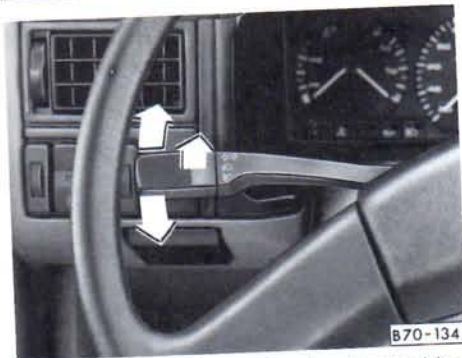

The turn signals only work when the ignition is switched on.

Right turn signals – lever up

Left turn signals – lever down

When turn signals are working, the warning lamp flashes as well – see page 48 also.

The turn signals cancel automatically after completing a turn.

To signal a lane change

Move lever up or down to pressure point and hold in this position – the warning lamp must also be flashing.

To dip headlights

Pull lever past pressure point towards steering wheel. When high beams are on, the high beam warning light will light up.

Headlight flasher

Pull lever towards steering wheel to pressure point – the high beam warning lamp lights up.

Parking lights

The parking lights only work when ignition is switched off.

Right parking lights – lever up

Left parking lights – lever down.

Note

The use of the signals and lighting described here is subject to local regulations.

Cruise control system*

To relieve the foot on the accelerator pedal this system can hold any speed above about 35 km/h constant, insofar as engine output permits.

Attention

The cruise control system should not be used in dense traffic and poor road conditions (slippery surfaces, aquaplaning, gravel).

When system is switched on do not move into neutral without depressing the clutch pedal, otherwise the engine will race and can, under certain circumstances, become damaged.



B33 - 696

The system is operated with the sliding switch A and the press button B on the turn signal lever.

The system is **switched on** by moving switch A to I.

When the speed to be maintained has been reached the press button B (FIX) must be pressed briefly. The foot can then be taken off the accelerator pedal.

The programmed speed can also be increased without pressing the accelerator pedal. The button B need only be pressed until the desired speed has been reached.

The speed can also be increased in the normal way with the accelerator pedal. When the pedal is then released the previously programmed speed is resumed.

The system is **temporarily switched off** when brake or clutch pedals are used or when speed is considerably below programmed speed i.e. when driving up a steep gradient in too high a gear.

To resume speed previously programmed when brake or clutch pedals are released or at end of gradient, push switch A to the left (AUFN).

Attention

The programmed speed must only be resumed when it is not too high for the existing traffic conditions.

The system is **completely switched off** by moving the switch A to the right (0) or – when vehicle is stationary – by switching the ignition off.

Windscreen wiper and washer system



Wipers and washers only work when ignition is switched on.

The heated windscreen washer jets* are switched on when the ignition is switched on and the amount of heat is regulated automatically according to the ambient temperature

When it is freezing, check that the wiper blades are not frozen to the glass before switching the wipers on for the first time.

Windscreen

■ Flick wipe

Lift lever to pressure point before detent 1.

■ Wiper slow

Lever at position 1.

■ Wiper fast

Lever at position 2.

■ Intermittent wipe

Lever at position 3

The wipers work about every 6 seconds.

With an **infinitely variable intermittent wipe*** the wipe delay can be programmed between about 1.5 and 22 seconds:

- Switch on intermittent wipe
- Switch off intermittent wipe and then switch on again after the desired delay.

The selected delay can be changed as often as required. After switching off the ignition the selected pause reverts back to a six second interval.

■ Automatic wash/wipe facility

Pull lever towards steering wheel – wipers and washer work.

Release lever –

The washer stops and the wipers carry on for about 4 seconds.

Headlight washer system*

When the headlights are on, the lenses are washed every time the windscreen is washed.

At regular intervals such as when filling the tank, caked-on dirt and insects should be removed.

Rear window

Press lever away from steering wheel and release – the wiper works about every 6 seconds (intermittent wipe). Pressing and releasing lever again switches the wiper off.

Automatic wash/wipe

Press lever away from steering wheel, and hold in this position –
The wiper and washer work as long as the lever is held in this position.

Release lever –

The washer stops and the wiper carries on for about 4 seconds.

Notes

- Topping-up washer fluid – see page 108.
- Changing windscreen wiper blades – see page 109

Heating and ventilation

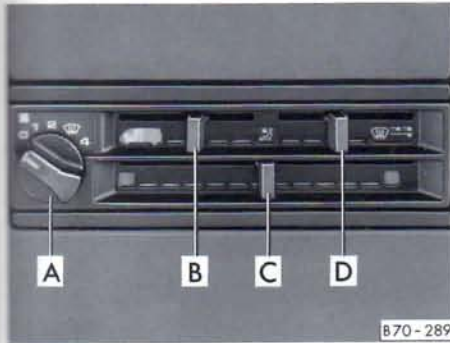

Controls

Blower switch A

The air flow can be regulated in four stages. When driving slowly the blower should always be running at least in stage 1.

Lever B – Air distribution (Footwell)

Lever D – Air distribution (Head area)

Lever C – Temperature selection

To right – increases heat
To left – decreases heat



Air vents

Depending on the position of levers B and D heated or unheated fresh air flows from vents 1, 2, 4 and 5. Only cold air flows from vents 3.

The vents 3 and 4 can be opened and closed separately:

Knurled disc up – vent closed.
Knurled disc down – vent opened.

By swinging the complete outlet grille of vents 3 and 4 the air flow can be moved vertically.

When the knurled disc in the grille is rotated to and fro the air flow direction is altered laterally.

The vents 2 serve to defrost the windscreen wiper blades.

Defrosting windscreen and side windows

- Rotary switch A to stage 3
- All levers to the right
- Vents 3 closed
- Adjust vents 4 so that additional warm air can be directed to the side windows.

Demisting windscreen and side windows

When the windows mist up due to high air humidity, e.g. when it is raining, we recommend the following settings:

- Rotary switch A to stage 2 or 3
- Lever C if necessary, to right into heating range
- Lever D to right
- Vents 3 closed
- Adjust vents 4 so that additional warm air can be directed to the side windows.

Heating interior quickly

- Rotary switch A to stage 3
- Lever C to right
- Lever B to left
- Vents 3 closed
- Vents 4 opened.

Heating interior comfortably

When the windows are clear and the desired interior temperature has been reached, we recommend the following settings:

- Rotary switch A to stage 1 or 2
- Lever C at the desired heat output
- Levers B and D set to desired air distribution. If the windscreen once again becomes misted up, move levers B and D to the right.
- Vents 3 closed
- With vents 4 the desired amount of warm air and the air flow direction can be set.

Ventilation (fresh air operation)

With the following settings, unheated fresh air flows from vents 3 and 4:

- Rotary switch A to desired stage
 - Lever B to right and lever D to left
 - Lever C fully to left
 - Vents 3 and 4 open
- If required, levers B and D can be set to other positions.

Notes

- To ensure that the heating and ventilation can work properly, the air inlet in front of the windscreen should be kept free of ice, snow and leaves.
- All controls except the rotary switch A can be set to any intermediate position.
- To prevent the windows from misting up the blower should be running slowly when driving at low speeds.
- The heat output depends on the coolant temperature – the full heat output is therefore only available when the engine is warm.
- The stale air escapes through ventilation slots in the luggage compartment/loading area side panel trim. Therefore these slots should not be covered. On vehicles with a full-width partition and on the Pick-up and Double Cab models the stale air escapes through slots in the front doors.

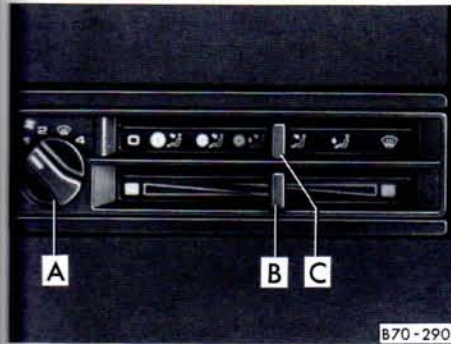
Air conditioner* in cab

Description

The air conditioner is a combined cooling and heating system which provides the maximum possible comfort all the year round.

The air conditioner works only when the engine is running and the ambient temperature is above about + 5 degrees C.

When air conditioner is switched on it reduces not only the temperature inside the vehicle but also the air humidity. When the ambient air humidity is high this not only makes the vehicle occupants feel more comfortable but also prevents the windows from misting up.

The cooling system works best when all the windows are closed.

Controls
A – Blower switch

The blower has four speeds.

B – Temperature lever

The temperature can be regulated over the full range for each programme lever position.

C – Programme lever
☐ – System switched off
☄ – Maximum cooling

(Temperature lever B fully to left) Air from side and centre outlets

☄ – Cooling normally

(Temperature lever position as required)
Air from side and centre outlets

☄ – Comfort setting

(Temperature lever position as required)
Air comes from the side and centre outlets and into footwell. Slight flow of air to windscreen and side windows.

☄ – Ventilating

(Depending on position of temperature lever, heated or unheated fresh air – not cooled air)
Air from side and centre outlets.

☄ – Heating

(Temperature lever position as required)
Air to the footwell, slight flow of air to windscreen and side windows and the side and centre outlets

☄ – Defrosting and demisting

(Temperature lever position as required)
Air to windscreen and to side windows, slight flow of air to footwell and to the side and centre outlets.

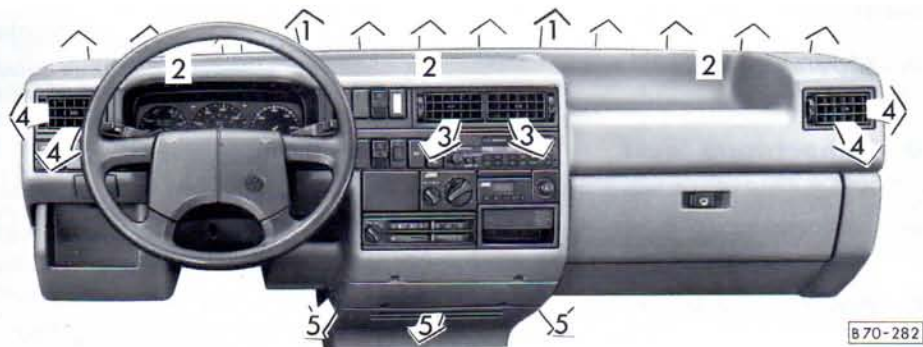

Air vents

Depending on the position of lever B heated or unheated fresh air or cooled air flows from all vents.

The vents 3 and 4 can be opened and closed separately:

Knurled disc up – outlet closed.
Knurled disc down – outlet open.



By swinging the complete outlet grille of vents 3 and 4 the air flow can be moved vertically.

When the knurled disc in the grille is rotated to and fro the air flow direction is altered laterally.



The outlets 2 serve to defrost the windscreen wiper blades.

Setting instructions



Defrosting windscreen and side windows

- Move upper lever to position .
- Move lower lever fully to the right.
- Set blower switch to stage .
- Close centre outlets.
- Direct side outlets to side windows.
- For optimum defrosting of the windscreen the side outlets should also be closed.



Demisting windscreen and side windows

- Move upper lever to position .
- For very effective demisting of the windows, the cooling system switches in automatically from about + 5° C ambient temperature.
- Move the lower lever into the heating range at low ambient temperatures, and at high temperatures and high air humidity (tropics) into the cooling range.
- Set blower switch to stage  or 4.
- Close centre outlets.
- Direct side outlets towards side windows.

Heating interior quickly

- Move upper lever to .
- Move lower lever fully to the right.
- Set blower switch to .
- Close centre outlets.
- Direct side outlets towards side windows.

Heating interior comfortably

- Move upper lever to  (comfort setting) or to  depending on where you would like the air flow to be.
- Set air temperature as desired with lower lever.
- Set blower switch to stage 1 or 2.
- Adjust side and centre outlets as required. At low ambient temperatures it is advisable to close the centre outlets and direct flow from side outlets towards the side windows.



Fresh air operation

- Move upper lever to .
- Set air temperature as desired with lower lever.
- Set blower switch to desired stage.
- Adjust side and centre outlets as required.

Maximum cooling

- Close all windows.
 - Move upper lever to .
 - Move lower lever fully to left or set as required.
 - Set blower switch to stage 4.
 - Adjust side and centre outlets as required. However, at least one outlet must always be open otherwise the cooling system may ice up.
- With this setting the air is drawn from inside the vehicle and cooled (recirculating air operation).

Normal cooling

- Move upper lever to  or .
- Set air temperature as desired with lower lever.
- Set blower to stage 1 – 4 as desired.
- Adjust side and centre outlets as required. In position  at least one outlet must always be open otherwise the cooling system may ice up.

With this setting ambient air is drawn in and cooled.

Notes

Pools of water under the vehicle

■ When the ambient temperature is high and the air very humid, condensed water can drip off the evaporator and form a puddle under the vehicle. This is quite normal and does not indicate a leak.

Operating faults

■ Should the air conditioner not work at any time, either:

- the ambient temperature is below about + 5 degrees C,
- the fuse has blown.

Check fuse and if necessary renew it – see page 122. If the trouble is not due to a defective fuse, switch the system off and have it checked.

– the air conditioner has switched off due to the coolant temperature being too high – see page 41 also.

■ If the cooling output drops off, switch the A/C off and have the system checked.

Using air conditioner economically

In cooling operation the air conditioner compressor places demands on the engine and therefore influences the fuel consumption. To keep the period switched on as short as possible, the following points should be noted:

■ If the inside temperature is very high after the vehicle has been parked in the sun, it is recommended to open doors or windows briefly to enable the hot air to escape.

■ The air conditioner should not be switched on during a journey if the windows or sliding/tilting roof* are open.

■ If the desired interior temperature can be attained without switching on the air conditioner, the fresh air operation should be selected.

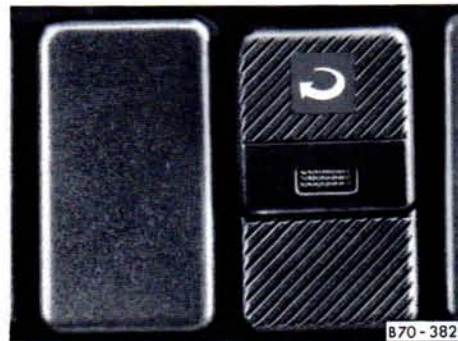

Recirculating air switch

If badly contaminated air is to be prevented from entering the vehicle, e.g. when driving through a tunnel, the recirculating air switch in the instrument panel can be pressed.

When the recirculating air system is switched on, a small warning lamp lights up in the switch.

However, the recirculating air system should only be used for a short period otherwise the windows will mist up.

Air conditioner* in passenger compartment



B70-293

With the air conditioner in the passenger compartment the rear seating area can also be comfortably cooled down.

The air conditioner only functions if the air conditioner in the cab is switched on – see page 57. However, adjustment of the output can be performed independent of the system in the cab. The control elements are located on the dash panel – see illustration.

The air throughput can be set in any one of four stages (left hand rotary switch).

The temperature infinitely variable with the rotary control (right hand switch).

Clockwise – increased cooling output

Anti-clockwise – decreased cooling output

Air outlets

The air outlets are located in the roof area above the rear seats.

The outlets can be closed or opened separately.

By pivoting the outlet grilles the direction of air flow can also be adjusted.

Recirculating air switch*



B70-294

This switch can be used to change over to recirculating air. This will prevent badly contaminated air from entering the vehicle, e.g. when driving through a tunnel.

Recirculating air operation should only be used briefly otherwise the windows will mist up.

Switch to left – Recirculating air operation

Switch to right – Fresh air operation

Note

On vehicles with air conditioner a recirculating air switch is located in the bank of switches in the instrument panel.

Additional heater*



With the additional heater the rear seating area can also be comfortably heated.

Its blower can be switched on with a three stage rotary switch in the dash panel (left hand illustration).

Temperature regulation is carried out together with the temperature regulation of the normal heater – see page 55 .



On vehicles with an air conditioner temperature regulation for the additional heater is by way of a rotary control on the right adjacent to the blower switch (centre illustration).

Clockwise – increased heat output

Anti-clockwise – decreased heat output



On vehicles with seating arrangement the outlet is located under the centre row of seats. This outlet can be closed by pushing it in.

On the Delivery van, Multivan and Camper the outlet is located behind the front passenger's seat.

Auxiliary heater*

The auxiliary heater works independently of the vehicle heating. It is supplied with fuel from the vehicle tank.

The auxiliary heater can be used continuously when on the move or stationary.

The current is supplied from a 2nd battery.

The air flows from the outlets behind the driver's seat.

In the summer the heater blower can be used to circulate the air in the vehicle without heat.

Switching on and off and regulating the auxiliary heater are done from the control panel in the dash panel.

If a timer* is fitted (see page 65) the control panel is located on the roof cross member in the passenger compartment.

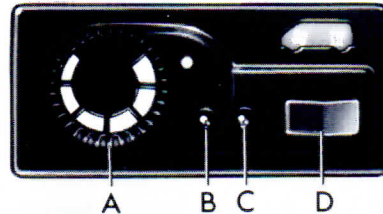

B.70 - 197

Control elements

- A – Regulating heat output
- B – Overheating indicator (red)
- C – Heater in-operation lamp (green)
- D – Rocker switch for switching heater on and off and operating blower without heat.

To switch heater on

■ Press rocker switch D on right.

■ Select desired heat with knob A.

The green heater in-operation lamp C comes on.

Regulating heat

The heat is infinitely adjustable with the knob A.

After heater has been switched on it takes a little time before heat can be felt.

When the set temperature is reached, the green in-operation lamp becomes darker. The temperature is then held fairly constant by the heater thermostatically.

To switch heater off

■ Move rocker switch D to centre position. The heater in-operation lamp C then goes out, but the blower continues to run for a short time.

Note

The warning lamp B flashes if the heater overheats. If this happens, check whether the air intake or the warm air outlet are blocked.

Switching blower on without heat

Press rocker switch D on the left. The green in-operation lamp C comes on.

Switching off

■ Move switch D to centre position. The in-operation lamp goes out. Stipulation is that the heater is not being controlled at the same time by the timer (see next page).

Attention

The heater must be switched off in enclosed spaces and when filling the tank.

Notes

- Every time the heater is switched off the blower continues to run for a while to cool the heater down quicker. When filling tank it is not necessary to wait to end of run-on.
- When driving cross-country or through mud or deep snow the heater exhaust pipe can become blocked. Before switching the heater on in these conditions, check that the pipe is clear.

■ The following official regulation is applicable in Germany:

The heat exchanger of the heater may be used for 10 years. After this period the heat exchanger must be replaced by a Genuine heat exchanger in a Volkswagen Dealership. To enable this period of time to be monitored the year when the heater is taken into use is marked on the maker's plate on the heater (under vehicle floor).

The Volkswagen dealer enters the date of replacement on the plate on the heater.

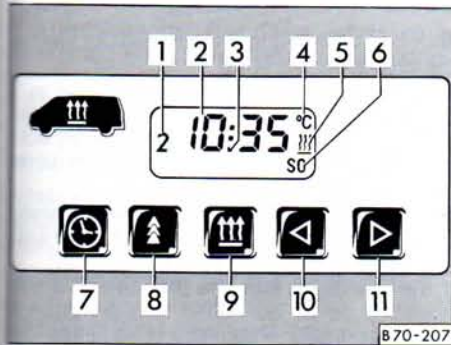

B.70-207

Timer*

With the timer in the instrument panel up to three different switch-on times can be selected for the auxiliary heater*. It is thus possible to start the heater without having to go to the vehicle.

The heater runs for maximum 120 minutes and it switches itself off. It can be switched off prematurely by pressing button 9. The preset time is stored and can be called up again so that the heater switches on again at the same time.

The switch-on time can be programmed up to one week in advance.

- 1- Display for 3 possible pre-selected times
- 2- Time display/pre-selected time
- 3- System malfunction display
- 4- Temperature display*
- 5- "On" or "Off" display
- 6- Display for pre-selected day
- 7- Push button for time and day of week
- 8- Push button for selecting time and day
- 9- Push button for "On" or "Off"
- 10- Push button for re-setting time or pre-selected time and calling up remaining running time
- 11- Push button for setting time or pre-selected time, setting pre-selected day and temperature display*

Notes

- As a temperature sender is not fitted at the factory an incorrect temperature figure appears when button 11 is pressed.
- Displays 2 and 6 appear continuously after switching on the ignition. After switching off the ignition both displays will only appear if button 7 is pressed.

Setting the actual time

- Press and hold button 7.
- Set correct time with buttons 10 or 11.

Setting the actual day of week

- Press and hold button 7.
- Set correct day of week with button 8.

Switching heater on (without preset operation)

- Press button 9; symbol 5 appears in the display.

A prerequisite is that rocker switch D on control panel of heater is in centre position.

With the ignition switched off the heater will be switched on for approx. max. 120 minutes.

The remaining running time can be called up by pressing button 10 briefly. If the button is pressed longer than one second, the running time will be shortened.

Note

If continuous operation of the heater is wanted, it must be switched on at the control panel (see page 63).

Switching heater off

- Press button 9/symbol 5 disappears.

Setting the pre-selected times

- Press button 8/the three possible pre-selected times and actual time can be called up separately as follows:

1st pre-selected time
2nd pre-selected time
3rd pre-selected time
Actual time
etc.

At the same time the day of week is displayed in each level.

For the initial input and for each change to an old input first call up the corresponding pre-selected time level with button 8. It is then possible to set the desired pre-selected time in each level with buttons 10 or 11. If a time is set before the actual time of day, the next day of the week appears in the display automatically.

If a different day of the week is desired, it is necessary to wait until the weekday display flashes before setting the new day of the week by pressing button 11.

The inputs are stored in the memory if no further inputs are made within about 10 seconds after setting a pre-selected time and day of the week. With the ignition switched on the actual time is displayed, with the ignition switched off the display disappears. However the numbers 1, 2 or 3 remain in the display 1 to indicate that a pre-selected time is activated.

Notes

- If not activated the heater will not start at the pre-selected time!
- Only one pre-selected time can be activated, which in turn also runs only once. However, the time can be repeated by activating again. When doing this the inputs remain stored in the memory.
- The switched-on period is determined as described in the "Switching heater on" section (see previous page). If the activation (not the pre-selected settings!) is to be cancelled, press button 8 until the number in display 1 is no longer visible.

Additional water heater*

The additional water heater heats the coolant in the heater circuit and supplies the normal heating heat exchanger and the additional heat exchanger* for heating up the passenger compartment with heated coolant. The engine coolant circuit is not heated.

The current is supplied from a 2nd battery.

Switching on and off and pre-selecting the switch on/off times is effected via the timer, which can be found in the instrument panel.

The air distribution and the air flow is effected via the normal heating and ventilation control elements (operating see page 55).

The additional water heater can be used when stationary (short term operation) or during the journey (continuous operation). If used when the vehicle is stationary the heater runs for maximum 30 minutes, thereby preserving the battery. Apart from this it switches off automatically, when a coolant temperature of 92 degrees C is reached.

When the coolant temperature has dropped below 84 degrees C the heater switches on again.

The additional water heater is supplied with fuel from the vehicle tank. It consumes up to 1 litre of fuel per hour. The heater output is approx. 7.0 kW.

Notes

- If the coolant temperature in the heater circuit reaches 55 degrees C, the fresh air blower is automatically switched to stage 2.
- The additional water heater will only switch on when the temperature selector lever (see page 55, lever C) is pushed fully to the right.
- With the heater switched on the temperature selector lever must not be pushed to the left.
- Regulating the heat output is not possible with the temperature selector lever.
- When driving across country through mud or deep snow the heater exhaust pipe can become blocked. Therefore under these conditions check that the pipe is clear before switching on the heater.

Attention

The heater must be switched off in confined spaces and when filling the tank.

- Each time the heater is switched off the circulation pump and the combustion blower continues to run for a while to cool down the heater unit quicker. When filling the tank it is not necessary to wait for the end of the run-on.

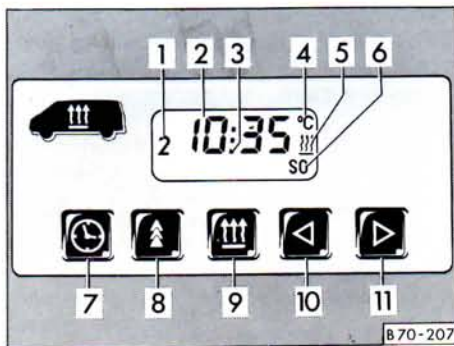

Timer

With the timer in the instrument panel up to three different switch-on times can be selected for the additional water heater. It is thus possible to start the heater without having to go to the vehicle.

The heater runs for maximum 30 minutes and then switches itself off. It can be switched off prematurely by pressing button 9. The preset time is stored and can be called up again so that the heater switches on again at the same time.

The switch-on time can be programmed up to one week in advance.

- 1- Display for 3 possible pre-selected times
- 2- Time display/pre-selected time
- 3- System malfunction display
- 4- Temperature display*
- 5- "On" or "Off" display
- 6- Display for pre-selected day
- 7- Push button for time
- 8- Push button for selecting time and day
- 9- Push button for "On" or "Off"
- 10- Push button for re-setting time or pre-selected time and calling up remaining running time
- 11- Push button for setting time or pre-selected time, setting pre-selected day and temperature display*

Notes

- As a temperature sender is not fitted in the factory an incorrect temperature figure appears when button 11 is pressed.
- Displays 2 and 6 appear continuously after switching on the ignition. With the ignition switched off both displays will only appear if button 7 is pressed.

Setting the actual time

- Press and hold button 7.
- Set correct time with buttons 10 or 11.

Setting the actual day of week

- Press and hold button 7.
- Set correct day of week with button 8.

Switching on heater (without pre-set operation)

- Press button 9; symbol 5 appears in the display.
- A prerequisite is that the temperature selector lever is pushed fully to the right.

With ignition switched off the heater will be switched on for approx. max. 30 minutes.

The remaining running time can be called-up by pressing button 10 briefly. If the button is pressed for longer than 1 second, the running time will be shortened.

Note

Continuous operation of the additional water heater is only possible with the ignition switched on. Additionally the heater must be switched on at the timer with button 9.

Switching heater off

- Press button 9; symbol 5 disappears.

Note

After switching off the heater the circulation pump and the combustion blower continues to run for 2 minutes.

During this time the temperature selector lever must not be pushed to the left – danger that heater unit will overheat!

Setting the pre-selected times

- Press button 8/the three possible pre-select times and the actual time can be called up one after the other as follows:

1st pre-selected time

2nd pre-selected time

3rd pre-selected time

Actual time

etc.

Simultaneously the day of the week is displayed at each level.

For the initial input and for each change to an old input first call up the corresponding pre-selected time level with button 8. It is then possible to set the desired pre-select time at each level with buttons 10 or 11. If a time is set before the actual time of day, the next day of the week appears automatically in the display.

If a different day of the week is desired, it is necessary to wait until the week day display flashes before setting the new day of the week by pressing button 11.

The inputs are stored in the memory if no further inputs are made within about 10 seconds after setting a pre-select time and day of the week. With the ignition switched on the actual time is displayed, with the ignition switched off the display disappears. However the numbers 1, 2 or 3 remain in the display 1 to indicate that a pre-selected time is activated.

Notes

- If not activated the heater will not start at the pre-selected time!

■ Only one pre-selected time can be activated, which in turn only runs once. However, the time can be repeated by activating again. When doing this the input remains stored in the memory.

- The switched-on period is determined as described in "Switching heater on" (see previous page).

If the activation (not the pre-selected settings!) is to be cancelled, press button 8 until the number in display 1 is no longer visible.

CONTROLS AND EQUIPMENT

Sun roof*

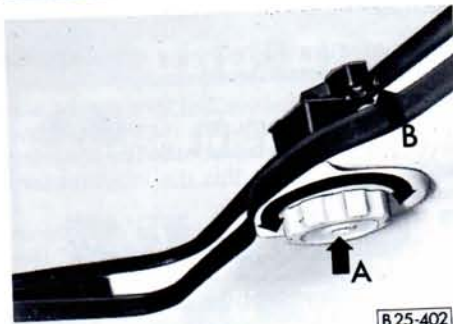

The roof is opened and closed with the hand-wheel.

The roof can be tilted at the rear as desired or taken out altogether.

Raising

Turn the hand-wheel clockwise.

Lowering

Turn the hand-wheel anti-clockwise.

To take out

- With the roof closed turn the retaining screw (A) in centre of the hand-wheel one quarter turn clockwise with a screwdriver.
- Then raise the roof and press it up.
- Press up locking lever (B).
- Detach the roof.
- Lift the roof from outside and pull it out to the rear.

To put back

- Slide the roof back into the hinges and let it drop lightly into the retainers.

Attention

Ensure that the roof is properly inserted into the two retaining hinges at the front, and secured at the rear.

The roof must only be released when vehicle is stationary.

Sliding/tilting roof*

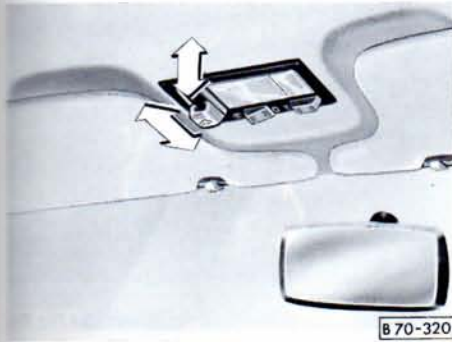

With ignition switched on, the roof can be opened and closed with switch.

To open

Slide switch to rear.

To close

Slide switch to front.

To lift at rear

With roof closed, press switch up at rear.

To lower

Pull rear of switch down.

Note

■ When opening the glass roof the screen to prevent sun rays shining in will also open automatically. If required it can be closed by hand when the roof is closed.

Attention

Be careful when closing the roof! Careless or uncontrolled closing of the roof could cause injuries. Therefore, when leaving the vehicle always take the ignition key with you.

Emergency operation

If the system should develop a fault the roof can be closed by hand.

- Using a screwdriver, press the cover in front of the sliding/tilting roof panel upwards at the rear and take off.
- Turn protective cap of crank opening clockwise.
- Pull crank out of retainer, insert it in the opening and close sliding roof.
- Replace crank in retainer, and fit protective cap over crank opening.
- Replace cover.

Interior lights

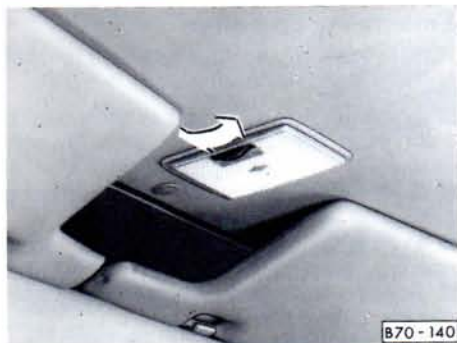

Front interior light

Switch positions:

Front: Light on continuously

Centre: Off

Rear: Door contact switch

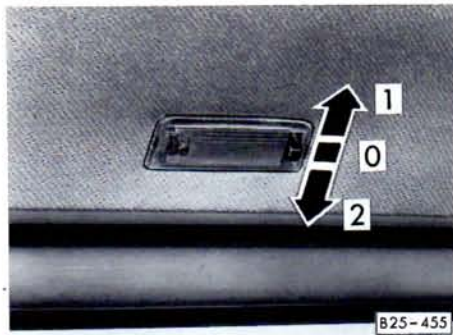

Rear interior light

Switch positions:

1: Light on continuously

0: Off

2: Door contact switch

Engine compartment light*



This light works when side or headlights are on.

It is located on the inner side of the bonnet and is switched off or on with a rocker switch – see illustration.

Sun visors

The sun visors can be pulled out of the centre mountings and swung towards the doors.

The make-up mirror can also have a sliding cover*.

On the mirror with light* (illustration), moving the sliding cover switches mirror lighting on and off. The lighting is also automatically switched off and on when the sun visor is raised or lowered.

Ashtrays

Ashtray in dash panel

To empty – Open ashtray, press spring down and pull ashtray out.

To replace – Push ashtray into the guides.

Ashtray in passenger compartment

Removing:

Open ashtray, press down and take out.

Replacing:

Insert ashtray in from above and then push fully in.

Cigarette lighter

The **cigarette lighter** is switched on by pushing in the element. When the heating element glows, the lighter springs back automatically – pull it out immediately and use it.

The **cigarette lighter socket** can be used for other electrical accessories with a capacity of up to 120 watts. When the engine is not running this will however discharge the battery. Further information see chapter Accessories on page 117 .

Attention

Be careful when using the cigarette lighter!

Careless or uncontrolled use of the cigarette lighter can cause burns.

The cigarette lighter and the socket also work when the ignition is switched off and the key removed.

For this reason children should never be left in the vehicle on their own.

CONTROLS AND EQUIPMENT

Glove box

The lockable lid* in the instrument panel can only be opened with the main key.

Attention

For safety reasons all storage box lids should always be closed when vehicle is moving.

Dropside (Pick-up)



To lower the dropsides pull locking handle outwards until the pin is clear of retaining hole then swing handle down.

On vehicles with support cables for the tailboard do not place more than 150 kg on tailboard when it is down.

Roof rack

When loads are to be carried on the roof, the following should be noted:

- As the rain channels are moulded into the roof for streamlining reasons, the normal type of roof rack cannot be used. To avoid risks we advise that only the cross bars provided by the factory are used.
- These cross bars are the basis for a complete roof load carrying system. For safety reasons when carrying luggage, bicycles, surf boards, skis and boats, the appropriate special adapters are required. All the components of this system are available from Volkswagen dealers.

- The roof rack system must be secured exactly as described in the instructions supplied.

- Any damage which may occur to the vehicle as a result of using other roof load carrying systems or by incorrect fitting will not be covered by the Warranty.

- Distribute the load evenly. Each cross bar may carry 50 kg if loaded uniformly over the full length. The permissible roof load (including the carrier system) of 100 kg and the permissible gross vehicle weight must not be exceeded – see page 148.

- When carrying heavy or large objects on the roof, bear in mind that the vehicle handling changes due to the displacement of the centre of gravity and the increased area exposed to the wind. Driving style and speed must be adapted to allow for this.

DRIVING TIPS

The first 1500 km – and afterwards

Running-in

During the first few operating hours the engine internal friction is higher than later on when all the moving parts have bedded down. How well this running-in process is done depends to a considerable extent on the way the vehicle is driven during the first 1500 km.

Up to 1000 kilometers

the following general rules apply:

- **Do not use full throttle**
- **Do not drive faster than 3/4 of top speed**
- **Avoid high engine speeds**
- Trailer towing should if possible be avoided.

Attention

- **New tyres must also be "run in" because they do not have maximum adhesion at the start. This must be taken into account by driving carefully during the first 100 km.**

■ **New brake linings must also be run in and do not have the optimum friction properties during the first 200 km. The slightly reduced braking effect can be compensated for by more pressure on the brake pedal. This also applies when new linings have been fitted.**

From 1000 – 1500 km

The speed can be gradually increased to the road or engine maximum.

During and after the running-in period the following applies:

- Do not overrev the engine when cold – either in neutral or in the gears. All speeds and revs given are only valid when engine is **properly warm.**

✿ *Do not drive with the engine speed unnecessarily high – changing up early helps to save fuel, reduces noise and protects the environment – see also page 79.*

- Do not let engine labour – change down when engine no longer runs smoothly.

After the running-in period

■ On vehicles with gear change marks on the speedometer dial the gears must be changed up at the latest by the time the needle reaches the marks.

■ On vehicles with a rev counter* the maximum permissible engine speed is shown by the beginning of the red zone on the rev counter scale. The needle of the counter must not move into this zone.

The additional red dotted area which some models have before the red zone can be used in isolated cases, for example when overtaking – see page 46.

If a rev counter is to be service installed the following maximum engine speeds must be marked on the scale:

Engine	Speed
Petrol engines	5300 rpm
Diesel engines	4300 rpm

On all petrol injection and Diesel engines the maximum engine speed is governed automatically.

Driving safely

Attention

The operational condition of your vehicle is essential to safe driving.

Therefore before moving off, always check the following points:

- **Lights and turn signals**
- **Mirror settings**
- **Cleanliness of headlights, lenses and windows**

Also check at regular intervals, preferably when filling the tank, all the checks listed on page 160

Furthermore compliance with the specified Inspection intervals – in particular the brake fluid changing – is of great importance for operational safety – pages 93 and 98.

Attention

Safety on the road depends to a large extent on the personal attitude and style of driving.

To be on the safe side you should:

- **Always put seat belt on before moving off – even in town traffic – and**

- **Ensure that all your passengers – including those on the rear seat – are wearing their belts correctly – page 15**

Passengers without seat belts can endanger not only themselves, but also the driver.

- **Adjust head rests to body size.**

The upper edge of headrest must be approximately at eye level.

- **Ensure that no articles interfere with operation of pedals – page 29.**

- **Stow all luggage correctly:**

- **in boot – page 28**
- **on the shelves – page 27**
- **on the roof – page 75**

- **Do not drive when you feel tired.**

Stop for a break at the latest after driving for two hours.

- **Never drive when your reactions are impaired in any way.**

Not only alcohol but also drugs and many medicines can be very detrimental to your reactions.

- **Adapt vehicle speed to traffic and road conditions.**

Remember that particularly on smooth slippery roads the handling and braking is limited by the adhesion of the tyres. On wet roads the front wheels can aquaplane at high speeds. The vehicle can then no longer be steered and braked properly.

- **Strictly adhere to the traffic regulations – particularly the speed limits –.**

Further instructions on safety are given in the various chapters in this manual.

Driving economically and ecologically

Various factors determine the fuel consumption, the burden on the environment and the wear on the engine, brakes and tyres.

The personal style of driving

Determines to a great extent the economical aspect and the exhaust and noise development:

Do not warm up the engine with the vehicle stationary.

At idling speed it takes a very long time until the engine becomes operationally warm. However, in the warm-up phase, wear and the discharge of pollutants is particularly high. For this reason, drive off immediately the engine has started and avoid high engine speeds.

Avoid full throttle acceleration.

Not only is the fuel consumption reduced considerably if one accelerates with feeling, but the disturbance to the environment and the wear are also reduced.

Do not drive with unnecessarily high engine revs – change up as soon as possible, only change down when the engine no longer runs smoothly.

The fuel consumption is for example more than twice as high in 2nd gear than it is in top gear. At the same time, the re-

duced engine speed means a reduction in engine noise.

On vehicles with an automatic gearbox the economy programme should be selected.

Try not to drive at maximum speed.

The fuel consumption, exhaust pollution and noise increase disproportionately at high speeds. If approximately only 3 quarters of top speed is utilised, the fuel consumption will be reduced by about half. Experience has shown that the loss in time is only marginal.

Drive as smoothly as possible and look well ahead.

Unnecessary acceleration and braking must be paid for with higher fuel consumption and more disturbance to the environment.

Switch the engine off during traffic hold-ups.

The individual operating conditions

Naturally also affect fuel consumption.

The following factors for instance are not favourable to good fuel consumption:

- High traffic density, particularly large towns with numerous traffic lights.
- Frequent stop/start driving, always restarting and warming up the engine.
- Driving in heavy, slow moving traffic in low gear so that the engine speed is relatively high in relation to the distance covered.

One should, therefore, plan trips in advance and try to avoid local traffic and overcrowded motorways.

Obviously the fuel consumption is also affected by factors over which the driver has no control. It is for example normal for the consumption to increase in the winter or in arduous conditions (bad roads, trailer towing etc.).

The technical prerequisites

for a low fuel consumption and efficiency were "built in" at the factory. Particular importance was placed on the lowest possible disturbance to the environment. To retain and make the best possible use of these characteristics attention should be paid to the following points:

✿ **Vehicles fitted with a catalytic converter may only be driven on unleaded petrol.**

✿ **Even those vehicles which do not have a catalytic converter should be driven on unleaded petrol for the sake of the environment.**

✿ **The prescribed maintenance operations should be carried out exactly as specified in the Service Schedule – see also page 93.**

Having your vehicle regularly serviced by a Volkswagen dealer not only ensures that it is always operationally fit, but it also ensures economy, lowest possible burden on the environment and a long service life.

✿ **Check the tyre pressures every 4 weeks.**

Low tyre pressures increase the rolling resistance. This not only increases the fuel consumption and tyre wear, but the handling is also impaired.

✿ **Do not carry unnecessary ballast in the luggage boot**

Particularly in town traffic when one has to accelerate often, weight has a great influence on the fuel consumption. As a rule of thumb: For every 100 kg of weight the consumption increases by approximately litre per 100 km.

✿ **Remove roof rack immediately after use**

Particularly at high speeds the increased air resistance makes itself felt considerably.

✿ **Electrical consumers should only be switched on when they are actually required**

Heated rear windows, additional driving lights and heater blower consume a considerable amount of current. The higher alternator load also increases the fuel consumption. For instance, over a period of 10 hours, the heated rear window will increase the fuel consumption by approximately 1 litre.

✿ **Check the fuel consumption regularly**

The fuel consumption should be checked each time the tank is filled up. By doing this inconsistencies on the vehicle which lead to an increased fuel consumption can be discovered sooner.

■ **Check the engine oil level each time the tank is filled up**

The oil consumption depends to a great extent on the engine load and speed. Depending on the style of driving the consumption can be as much as 1.0 litres/1000 km.

It is normal for the oil consumption of a new engine to reach its lowest level after a certain mileage has been covered. The consumption cannot be properly assessed until the vehicle has run approx. 5000 km.

This also applies to the fuel consumption and the engine output.

Trailer towing

The vehicle is intended mainly for the transportation of persons and luggage but it can, with the appropriate technical equipment, also be used to tow a trailer.

Trailer towing not only places more stress on the vehicle, it also calls for more concentration from the driver.

For this reason the operating and driving instructions on the next pages must be strictly adhered to.

Technical requirements

If the vehicle is supplied with a factory-fitted towing bracket, all that is technically and legally necessary for trailer towing will have been taken into account.

It should be noted that a 13 pin socket is fitted instead of the 7 pin one used previously. This new socket makes it possible to connect additional electrical components on the trailer for which there were no connections in the previous socket, such as a caravan refrigerator, reversing lights etc.

In the following table the wiring of the terminals in the 7 pin socket is compared with that of the 13 pin socket.

7 Pin	13 Pin	Trailer electrical components
L	1	Turn signal left
54g	2	Rear fog light
31	3 ¹⁾	Earth for the circuits 1-8
R	4	Turn signal right
58R	5	Tail light, outline -, marker - and number plate lights right
54	6	Brake lights
58L	7	Tail light, outline -, marker - and number plate lights left
-	8 ²⁾	Reversing light
-	9 ²⁾	Power supply (cont. +)
-	10 ²⁾	Charging wire + for battery in trailer
-	11	free
-	12	free
-	13 ¹⁾	Earth for circuits 9-12

1) Both earth wires must not be connected together on the trailer side.

2) Not connected at the factory.

If the trailer to be towed has a 7 pin plug, either a 13 pin plug can be fitted as shown in the table or an adapter cable can be obtained from a Volkswagen dealer.

If the vehicle is to be fitted with a towing bracket subsequently, the following must be noted:

■ The towing bracket is a safety part. Only a bracket which has been designed and type-approved for this vehicle may be used. It is advisable to use towing brackets from the Volkswagen range of accessories as these are identical to the ones fitted by the factory. The fitting instructions supplied with these brackets have also been approved by the factory.

■ The trailer socket must be connected properly to the electrical system of the vehicle. This applies to terminal 54 g in the 7 pin socket or for terminals 2 and 8-13 in the 13 pin socket.

■ As the factory installation of a towing bracket includes the modification of the cooling system, this should also be done when service installing a bracket. Otherwise overheating may occur when the engine is pulling hard (mountains, high ambient temperature, heavy trailer loads).

Certain vehicle versions can be equipped with a heavy-duty cooling system ex factory, even though the vehicle is delivered without a towing bracket. Details can be obtained from Volkswagen dealers.

■ Volkswagen dealers have all the necessary information on the installation of towing brackets and the fitting of a heavy-duty cooling system. The installation should therefore be done by them.

■ If, when towing a trailer for commercial purposes, the permissible total weight of vehicle and trailer – also with passenger cars – exceeds 3500 kg, it is necessary to install and use a tachograph in most European countries.

Operations instructions

■ When inserting the 13 plug into the socket on the vehicle, the ribbed sleeve on the plug must be turned fully to the right. The lid of the socket then engages over the boss on the sleeve.

■ If the traffic behind the trailer cannot be seen properly with the standard rear view mirrors, additional outside mirrors will be necessary. Both outside mirrors must be fitted on folding arms and adjusted to give a good view to the rear at all times.

■ Pitching movements between towing vehicle and trailer can be reduced by heavy-duty springs and shock absorbers on the rear axle. If these springs and shock absorbers have not already been fitted at the factory, they can, in many cases, be service-installed by a Volkswagen dealer.

■ Pitching and snaking movements can also be reduced by stabilizers which can be obtained from and fitted by Volkswagen dealers in most European countries.

■ The permissible trailer weight¹⁾ – see page 151 – must not be exceeded on any account.

■ When towing a trailer in mountainous regions, note that the trailer weights given in the "Technical data" are only valid for gradients up to 10 or 12 %. If the trailer weight is below the permissible maximum a correspondingly steeper gradient can be climbed.

■ The given trailer weights are only applicable for altitudes up to 1000 m above sea level. As the engine output and thus the climbing ability drops due to the decreasing air density, the weight of vehicle and trailer must also be reduced by 10 % for each further 1000 m or part thereof.

¹⁾ The permissible vehicle/trailer weight consists of the permissible total weight of towing vehicle plus the permissible total weight of trailer. If the permissible trailer load is to be fully utilized it may be necessary to reduce the weight of the towing vehicle appropriately. The towing vehicle must however not be lighter than the trailer.

■ Where possible make full use of the maximum permissible drawbar weight on ball of the towing bracket – see page 151 – but do not exceed it.

■ While observing the permissible trailer and drawbar weight, distribute the load in the trailer so that heavy objects are as near as possible to the axle. The objects must also be secured so that they cannot slip about.

■ Check the tyre pressures on the towing vehicle and the trailer.

■ The headlight settings, should be checked with trailer attached before moving off and adjusted as necessary. On vehicles with headlight beam control it is only necessary to turn the knurled disc in dash in the appropriate direction.

Driving instructions

To obtain the best possible handling of vehicle and trailer, the following should be noted:

■ Try to avoid driving with an unladen vehicle and a loaded trailer. If this cannot be avoided, only drive slowly to allow for the unfavourable weight distribution.

■ As driving stability of vehicle and trailer decreases when the speed increases do not drive at the maximum permissible top speed in unfavourable road, weather or wind conditions – particularly when going downhill.

In any case the speed must be reduced immediately the trailer shows the slightest sign of snaking. On no account try to stop the snaking by accelerating.

■ For safety reasons one should not drive faster than 80 km/h (50 mph). This also applies in countries where higher speeds are permitted.

■ Always brake in good time. If the trailer has an overrun brake, apply the brakes gently at first then firmly. This will avoid the jerking caused by the trailer wheels locking. Change down before going down a steep hill so that the engine can act as a brake.

■ When a long climb in a low gear with extremely high engine revs must be negotiated at exceptionally high ambient temperatures the coolant temperature gauge must be observed. When the gauge needle moves to the upper end of the scale, the road speed must be reduced immediately. If nevertheless the warning lamp flashes, stop immediately and allow the engine to cool off at idling speed for several minutes.

■ The cooling effect of the radiator fan cannot be increased by changing down, because the speed of the fan is not dependent on the engine speed. One should therefore not change down even when towing a trailer as long as the engine can cope without the vehicle speed dropping too much.

General notes

■ During the running-in period avoid trailer towing as much as possible.

■ It is advisable to have the vehicle serviced between the Inspection intervals if it is used frequently for towing a trailer.

■ The trailer and drawbar load figures on the data plate of the towing bracket are for test certification only. The correct figures for the vehicle, which may be lower than the above figures, are given in the vehicle documents and in this manual.

■ The towing bracket increases the unladen weight of the towing vehicle and the payload must be reduced to correspond.

In some countries (for example Germany) the following additional legal requirements apply:

■ A special warning lamp must be fitted within the driver's range of vision to show that the trailer turn signals are working.

■ The maximum draw bar weight – see page 151 – must be shown on a clearly visible sticker at the rear of the towing vehicle.

■ The installation of a towing bracket must be passed by a legally approved test centre and then proof of installation is entered in the vehicle documents by the traffic authority.

■ The maximum speed permissible when towing a trailer is 80 km/h (50 mph).

Filling the tank

The filler neck is on the left-hand side of the vehicle.

The tank holds about 80 litres.

Trouble-free refuelling calls for correct use of filler nozzle.

■ Insert nozzle fully into tank neck and do not tilt it.

On vehicles with a catalytic converter the spring-loaded flap below the filler opening must be pressed open with the filler nozzle. This should also be noted when using a petrol can to fill the tank.

 ***As soon as the correctly operated automatic nozzle switches off for the first time, the tank is full. Do not try then to put more fuel in because the expansion space in tank will be filled – the fuel can then overflow when it becomes warm.***

After filling tank, screw cap on tightly and lock it.

Note

■ **Never drive until the fuel tank is completely empty on vehicles with a catalyst. The irregular fuel supply can cause misfiring. This allows unburnt fuel into the exhaust system. Which can cause overheating and damage to the catalyst.**

■ When carrying a spare can of petrol on the vehicle, official regulations must be observed. For safety reasons we advise you not to carry a spare can of petrol. In an accident the can could become damaged and petrol escape.

Fuel

Petrol engines

Vehicles with catalyst

62 and 81 kW Fuel injection engines

Unleaded regular petrol
RON¹⁾ not lower than 91

✿ *On vehicles with catalytic converter only unleaded petrol may be used.*

The use of leaded petrol is very detrimental to the functioning of the emission control system because the lead is deposited in the catalytic converter.

✿ *Even one tankful of leaded petrol will detract from the efficiency of the catalytic converter.*

Although unleaded fuel may again be used afterwards the original efficiency of the catalytic converter is never fully attained.

On vehicles with Lambda probe²⁾ the mixture formation is also negatively affected.

¹⁾ **O**ctane **N**umber, indicates the ignitability of Diesel

²⁾ Lambda = Air/petrol relationship

Vehicles without catalytic converter

62 kW Carburettor engine
unleaded or leaded **regular petrol**
RON¹⁾ not lower than 91

✿ *In the interests of our environment unleaded petrol should be used whenever possible.*

Notes

■ Unleaded petrol must comply with DIN³⁾ 51 607 and leaded petrol with DIN 51 600.

■ Only good quality petrol containing additives should be used – see also “Petrol additives” next column.

■ If in an emergency the octane rating of the available petrol is lower than that required by the engine, only drive with medium engine speeds and low engine loading. **High engine loading with full throttle or high revs can cause engine damage.** Fill tank with petrol of the correct rating as soon as possible.

³⁾ Standards issued by the German Standards Institution.

Petrol additives

The quality of the fuel has a decisive influence upon the running behaviour, performance and service life of the engine. The additives which are mixed into the petrol are of particular significance. One is advised therefore only to use **good quality petrol containing additives.**

If such fuel is not available, or if engine troubles such as starting difficulties, stalling during idling, vibration and loss of power occur, the appropriate additives should be mixed with the petrol when filling the tank. At temperatures between about 0 and 15 degrees C, these additives prevent possible icing up of the carburettor, have an anti-corrosion effect, clean the fuel system and prevent deposits building up in the engine.

Petrol additives available in accessory outlets have not all shown themselves to be effective. Therefore additives which have been tested for Volkswagen engines are available from Volkswagen dealers in Germany and in many export countries. The Volkswagen dealers are also informed with regard to the use of additives, and they know what to do in cases where deposits have already built up.

Diesel engines

Diesel fuel
to DIN 51 601.

CN¹ not lower than 45.

Driving in winter

When using summer Diesel trouble may be experienced at temperatures below 0 degrees C because the fuel thickens due to wax separation.

For this reason, winter Diesel which is more resistant to cold is sold during the winter in Germany, and this works satisfactorily down to between -15 and -22 degrees C, depending on the type of fuel used.

In countries with different climatic conditions the Diesel fuels offered have a different temperature characteristic. Check with Volkswagen dealers or filling stations in the country concerned regarding the characteristics of Diesel fuels.

Filter preheating

The vehicle is fitted with a filter preheater. This will ensure, that the fuel system remains operational down to about - 25 degrees C provided that winter Diesel which is cold resistant down to - 15 degrees C is used. Diluting with petrol is then no longer necessary under these conditions.

If, at temperatures below - 25 degrees C the fuel is waxed to such an extent that the engine will not start it is sufficient to place the vehicle in a warm room for a while.

Fuel additives (anti-waxing agents and similar fluids) must **not** be mixed with the Diesel fuel.

¹ Cetane Number, indicates the ignitability of Diesel

Care of car

Regular and careful care helps to maintain the value of the vehicle.

Furthermore it can be one of the stipulations for the upholding of warranty claims should corrosion damage and paint defects occur.

Every Volkswagen dealer carries stocks of suitable car care materials. The instructions for use on the container should be followed.

Attention

■ **If misused, car care materials can be injurious to health.**

■ **Car care materials must always be stored in a safe place where they are out of the reach of children.**

✿ ***When buying car care materials one should select products which do not damage the environment. Empty containers which these materials were in do not belong with household waste.***

Washing

The best protection against environmental influences is frequent washing and waxing.

How often this treatment is required depends, amongst other things on how much the vehicle is used, how it is parked (garage, in open under trees etc.), the seasons, weather conditions and environmental influences.

The longer bird droppings, insects, tree resin, road and industrial grime, tar spots, soot, road salt and other aggressive materials remain on the vehicle paint the more lasting their destructive effect will be. High temperatures e.g. from strong sunlight intensifies the corrosive effect.

In certain circumstances weekly washing can be necessary, in other conditions monthly washing with appropriate waxing may be fully adequate.

After the period when salt is put on the roads the underside of the vehicle should always be washed thoroughly.

Automatic wash plants

The vehicle paint is so durable that the vehicle can normally be washed without problems in an automatic wash plant. However the influence on the paint depends to a large extent on the design of the plant, the filtering of the wash water, the type of wash and care material, etc. If the paint has a matt appearance after going through the wash plant or is even scratched this should be brought to the notice of the plant operator immediately. If necessary a different wash plant should be used.

Notes

■ Before going through the wash plant, apart from the usual precautions (closing windows and sliding roof, retracting the aerial) there is nothing further to note. However, to prevent damage the door mirrors should be folded in.

■ If there are special fittings on the vehicle – such as spoilers, roof rack, two-way radio aerial etc. it is best to speak to the plant operator.

Washing the vehicle by hand

 ***In the interests of environmental protection the vehicle should only be washed in specially provided wash bays. In some districts, washing cars elsewhere may even be forbidden.***

First soften the dirt with plenty of water and rinse off as well as possible.

Then clean the car with a soft sponge, glove or brush starting on the roof and going from top to bottom using only slight pressure. Paint shampoo should only be used for very persistent dirt.

Rinse the sponge or glove out thoroughly at short intervals.

Wheels and sill panels should be cleaned last, using a different sponge if possible.

After cleaning the vehicle, rinse thoroughly with water and leather it off.

Notes

- The vehicle should not be washed in strong sunshine.
- If the vehicle is rinsed with a hose, do not direct the jet of water at the lock cylinders – they can freeze up in the winter.

Washing vehicle with high pressure cleaner

- The operating instructions for the high pressure cleaner must be followed closely – particularly with regard to pressure and working distance.
- Do not use a concentrated jet.
- The water temperature must not be above 60 degrees C.

Attention

Tyres must never be cleaned with a concentrated jet! Even at a relatively large working distance and a very short spraying time, damage can occur.

Waxing

A good coat of wax protects the vehicle paintwork to a large extent against the environmental influences listed under "Washing" on the previous page and even against light mechanical damage.

At the latest when water on the clean paint does not form small drops and roll off, the vehicle should be protected by applying a coat of good hard wax. Even when a wax solution is used regularly in the washing water it is advisable to protect the paint with a coat of hard wax at least twice a year.

Polishing

Should only be done if paint has lost its shine and gloss cannot be brought back with wax. If the polish used does not contain preservative compounds, the paint must be waxed afterwards.

Note

Matt painted and plastic parts should not be treated with polish or hard wax..

Paint damage

Small marks in the paint such as scratches or stone damage should be touched up immediately with paint (Volkswagen touch-up stick or spray can) before the metal starts to rust.

However, should rust be found at any time it must be removed thoroughly and then the area treated first with an anti-corrosion primer and then the correct paint applied. You can of course have this work done by a Volkswagen dealer.

The number of the original vehicle paint is given on the data sticker (see page 154).

Windows

Remove snow and ice from windows and mirrors with a plastic scraper only. To avoid scratches due to dirt on the glass, the scraper should only be pushed in one direction and not moved to and fro.

Traces of rubber, oil, wax, grease or silicone can be removed with a window cleaning solution or a silicone remover.

The windows should also be cleaned on the inside at regular intervals.

Do not dry the windows with the leather used for the paintwork because traces of paint cleaner will cause streaks to appear on the glass.

To avoid damaging the **heating element wires** in the rear window do not put stickers over the wires on the inside.

Door, boot and window weatherstrips

The weatherstrips will remain flexible and last longer if they are rubbed lightly with a rubber protective compound from time to time. This will also stop the weatherstrips from freezing on in the winter.

Plastic parts and leatherette

Exterior plastic parts are cleaned with normal washing and interior parts with a damp cloth. If this is not sufficient, these parts and leatherette may only be cleaned with **special solvent-free** plastic cleaners.

Curtains

The curtains may only be cleaned chemically. They should not be washed as they could shrink, and/or the fire-resistant properties could be washed out.

Upholstery cloth and textile trim

Upholstery cloth and textile trim on door panels, parcel shelves, luggage compartment covers, headlining etc. must be cleaned with special cleaners or dry foam and a soft brush.

Cleaning seat belts

Keep belts clean because they may not retract properly if very dirty.

Dirty belts can be cleaned by washing with a mild soap solution without taking the belts out of the vehicle.

Note

Inertia reel belts should be completely dry before they are allowed to roll up.

Attention

Do not have the belts cleaned chemically because the cleaning compounds damage the webbing material. Ensure that the belts do not come into contact with corrosive fluids.

Steel wheels

The wheels and the wheel trims should be cleaned thoroughly at regular intervals when the vehicle is being washed. This will prevent brake dust, dirt and road salt from accumulating on the wheel. Persistent ingrained brake dust can be removed with an industrial grime remover. Paint damage should be repaired before rust can form.

Alloy wheels

In order to maintain the smart appearance of alloy wheels for a long period, regular care is necessary. In particular, salt and brake pad dust must be washed off thoroughly at least every two weeks otherwise the surface of the alloy will be damaged. After being washed, the wheels should be treated with an acid-free cleaner for alloy wheels. About every three months it is necessary to give wheels a good rubbing with hard wax. Paint polish or other abrasive solutions must not be used. If the protective paint coat has been damaged, e.g. by stone impact, the damaged spots should be dealt

with as soon as possible.

Cleaning and anti-corrosion treatment of engine compartment**Attention**

Before doing any work in the engine compartment it is essential to read the notes on page 95!

The engine compartment and the outside surface of the power unit are given anti-corrosion treatment at the factory.

In the winter when the vehicle is being driven frequently on salted roads, good anti-corrosion treatment is very important. For this reason the entire engine compartment should be thoroughly cleaned before and after the salting period and then preserved so that the salt cannot have a damaging effect.

The ignition must be switched off before washing the engine.

To prevent damage to the system the jet from the cleaning appliance must not be directed into the intake openings for the heating and ventilation. The openings are located above the air cleaner.

If the engine compartment is cleaned at any time with grease removing solutions¹⁾ or if one has the engine washed, the anti-corrosion compound is nearly always removed as well. It is therefore essential to ask for durable preservation of all surfaces, seams, joints and components in the engine compartment to be carried out. This applies also when corrosion protected parts are renewed.

Volkswagen dealers have stocks of the high-quality cleaning and preservation materials recommended by the factory and have the equipment necessary to apply them.

 **Because when washing the engine petrol, grease and oil deposits are washed off, the dirty water must be cleaned by an oil separator. For this reason engine wash-**

¹⁾ Only the correct cleaning solutions may be used – on no account petrol or Diesel.

ing should only be carried out in a workshop or filling station.

Undercoating

The underside of the vehicle is coated with a special compound to protect it from corrosion and damage.

However, as this protective layer becomes damaged when the vehicle is in use, the protective coating under the body and on the running gear should be examined at defined intervals – preferably before and after the winter season – and any damage made good.

Volkswagen dealers have stocks of the correct compound, have the necessary equipment and are familiar with the application procedure. We advise you therefore to have the patching up or additional coating done by a Volkswagen dealer.

Note for vehicles with a catalytic converter

Due to the high temperatures which occur in the afterburning process, additional heat shields are fitted over the catalytic converter. Underbody sealant must not be applied to these shields, the catalytic converter or the exhaust pipes. Removal of the heat shields is also not permissible.

Cavity preservation

All cavities on the vehicle which could be susceptible to corrosion are given permanent protection at the factory.

This coating does not need checking or any subsequent treatment. Should a small amount of wax run out of the cavities at high ambient temperatures it can be removed with a plastic scraper and some white spirit.



If the wax which has run out is removed with clean petrol, heed the environmental protection regulations.

Maintenance

As the vehicle is fitted with modern low maintenance technical components only small amount of regular servicing is required in order to maintain the roadworthiness, economy and reliability.

The Inspection Service offered by the Volkswagen dealers takes into account to a large extent the individual annual mileage covered and helps thus to keep the operating costs as low as possible.

 **Regular maintenance helps to ensure that the emissions – and thus the environmental burden are kept as low as possible.**

The **Inspection Service** is required **every 12 months** or **every 30 000 km**, whichever occurs first.

If a mileage of 15 000 km (petrol engines) or 7500 km (Diesel engines) is reached before 12 months has elapsed, the **Oil change Service** must be carried out. See page 98 also and the Service Schedule.

The Service Schedule also shows what work is done at the Inspection and Oil Change Services.

In arduous operating conditions, e.g. extremely low ambient temperatures, very dusty conditions etc. certain service operations should be carried out between the intervals specified.

This applies in particular to:

- Changing the engine oil
- Cleaning or changing the air cleaner element
- Draining water from or renewing the fuel filter on the Diesel engine

The service operations should be carried out by a Volkswagen dealer because this work requires specialist knowledge, workshop equipment and special tools. Furthermore this work must be done in accordance with our instructions.

Complete proof of servicing by a Volkswagen dealer can be one of the stipulations for the upholding of any warranty claims during the one year warranty period.

Attention

Safety regulations place very strict limits on the amount of repairs and adjustments to engine and running gear parts which can

be done by the owner. By tinkering with parts which affect the safety of a motor vehicle one can endanger oneself and other road users.

 **Altering the engine settings is detrimental to the exhaust emissions. This means that the environment is burdened unnecessarily and the fuel consumption also increases.**

The disposal of old oil, used brake fluid, dirty coolant, defective batteries or worn-out tyres etc. must be done according to environmental protection regulations.

It is even better if old operating fluids and parts are used again and do not become a burden on the environment. Through "recycling" valuable raw-materials and energy are saved and at the same time it relieves the load on the toxic waste dumps. Volkswagen dealers collect all reusable materials and parts and passes them on to the correct agency for recycling.

Bonnet



To release lock, pull lever on left under instrument panel until bonnet springs up slightly.



To open the bonnet press the safety catch in (arrow).

Lift bonnet until the strut engages.

Note

Before opening the bonnet ensure that the wiper arms are not lifted off the windscreen. Otherwise damage can occur to the paintwork.



To close bonnet lift it slightly and pull the strut forward – see illustration. Let bonnet drop into locks from a height of about 30 cm – do not press it closed.

■ Attention
■ For safety reasons the bonnet must always be properly closed when vehicle is moving. Always check therefore after closing the bonnet that the lock is engaged.

Should you notice at any time when driving that the bonnet is not properly secured, stop and close it.

Engine compartment



B.70 - 109

	Page
Windscreen washer container ...	108
Power assisted steering fluid reservoir*	100
Engine oil filler opening	97
Engine oil dipstick	97
Coolant expansion tank	102
Brake fluid reservoir	104
Battery	106

Attention

Particular care should be taken when working in the engine compartment!

- Switch off engine, remove ignition key.
- Pull handbrake on firmly.
- Move gear lever into neutral or "P" position.
- Allow engine to cool off.
- As long as the engine is at operating temperature:
 - Do not put your hand into the radiator fan, it could switch on suddenly.
 - Do not open the radiator cap because the cooling system is under pressure.
- Avoid causing short circuits in the electrical system - particularly at the battery -.

■ If tests have to be carried out with the engine running, there is an additional danger present from rotating parts - e.g. V-belts, generator, radiator fan etc. - and from the high voltage ignition system.

Attention must be paid to the warnings given in this Instruction Manual and to the generally applicable safety regulations.

When topping up fluids one should ensure that they are not mistaken, one for the other, under any circumstances, otherwise serious functional defects will result.

** So that leaks are quickly detected the ground underneath the vehicle should be checked regularly. If spots as caused by oil or other operating fluids can be seen, the vehicle should be taken to the workshop for checking.*

Engine oil

Viscosity and specification

A special, high quality multigrade oil is put in the engine at the factory and this can be used all the year round – except in very cold climates.

As a good engine oil is a prerequisite for trouble free operation and long engine service life, only a correspondingly high quality oil may be used for topping up and at oil changes.

The specifications shown on this page must be marked either separately or together with other specifications, on the containers.

When topping-up, the oils can be mixed with one another.

The **viscosity class** of the oil must be selected in accordance with the illustration. If the ambient temperature exceeds the given range briefly, the oil does not need to be changed.

Important note

Quite naturally engine oils are also being continually developed. For this reason the statements in this Instruction Manual are only in line with the current state at the time of going to press.

Volkswagen dealers are kept up-to-date by the factory regarding changes. For this reason the oil change should preferably be done by a Volkswagen dealer.

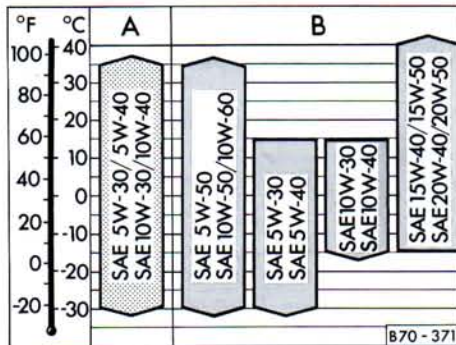

Petrol engines

- A – Multigrade – improved lubricity engine oils, specification VW 500 00
- B – Multigrade oils, specification VW 501 01
 - Multigrade oils, specification API-SF¹⁾ or SG¹⁾

¹⁾ These oils may only be used if the approved engine oils are not available.

Diesel engines

- A – Multigrade-improved lubricity oils, specification VW 500 00 (not for turbo-diesel engines)
- B – Multigrade engine oils, specification VW 505 00 (suitable for **all** diesel engines)
 - Multigrade oils, specification API-CD (with turbo-diesel only for topping-up in an emergency)
 - Multigrade oils – specification VW 501 01 (not for turbo-diesel engines)

Oil characteristics

Multigrade oils to VW Standard 501 01 are reasonably priced oils with the following properties:

- All year round use in temperate climate areas.
- Excellent cleaning capability.
- Efficient lubrication at all engine temperatures and load conditions.
- High resistance to ageing.

The multigrade-improved lubricity oils as per VW Specification 500 00

have in addition the following advantages:

- All year round use at practically all temperatures.
- Low frictional losses in the engine.
- Best possible starting even at very low temperatures.

Notes

■ **Single grade oils.** Due to their limited viscosity ranges these oils are not generally acceptable for all year round use. Therefore these oils should only be used in extreme climatic zones.

■ When using SAE 5 W-30 multigrade oil, continuous high engine speeds and engine loading should be avoided. This restriction does not apply to multigrade-improved lubricity oils.

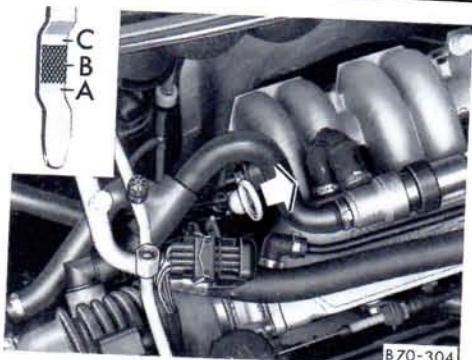

Checking oil level

Every engine uses a certain amount of oil. The **oil consumption** can be up to 1.0 litres per 1000 km – see also page 80. The engine oil level must therefore be checked at regular intervals, preferably when filling the tank and before a long journey.

The location of the dipstick is shown in the illustration.

The vehicle must be on a level surface when checking the oil level. After stopping engine wait a few minutes for the oil to drain back to the sump.

Then pull the dipstick out, wipe it with a clean cloth and insert again.

Then pull dipstick out again and check the oil level:

A – Oil **must** be topped-up. Afterwards it suffices when the oil level is somewhere in area B.

B – Oil **can** be topped-up. It can then happen that the oil level is in area C.

C – Oil **must not** be topped-up.

When the engine is working hard such as in sustained high-speed motorway cruising in summer, when towing a trailer or when climbing mountain passes, the oil level should be kept at area C (**not above**).

Note

If the dipstick does not have an offset in measuring area, the upper and lower ends of the etched area form the MAX. and MIN. marks. The oil level must be between the two marks. If it has dropped to the MIN. mark, oil must be added, **however on no account above the MAX. mark.**



Topping up engine oil

Unscrew the cap from oil filler opening and pour oil in 0.5 litres at a time. Then check level with the dipstick.

On no account must the oil level be above area C. Otherwise oil can be drawn into the engine via the crankcase breather and escape into the atmosphere via the exhaust system. On vehicles fitted with a catalytic converter, the oil could burn inside the converter causing it damage.

Attention
When topping up the oil, do not spill it onto hot engine components – danger of fire.

Carefully close the filler cap and push the oil dipstick in as far as possible, this will prevent oil spill when the engine is running.

Changing engine oil

Not only does the engine oil deteriorate due to use when the engine is running, but also to ageing. The engine oil change intervals depend therefore on the mileage and also on the time elapsed.

Petrol engines

Change engine oil every 15 000 km or every 12 months (whichever comes first).

Diesel engines

Change engine oil every 7500 km or every 12 months (whichever comes first).

For further details, see Service Schedule.

For petrol and Diesel engines

If the vehicle is used continuously in arduous conditions, the engine oil must be changed at shorter intervals – see also page 93.

Recommended oil and viscosity classes – see page 96.

Attention
Old oil must be stored out of reach of children until it is disposed of in the correct manner.

On no account must oil be poured down drains or into earth.

Because of the disposal problems, the necessary special tools and specialist knowledge required the engine oil and filter changing should preferably be done by a Volkswagen dealer.

Engine oil additives

No additives should be mixed with the engine oil.

Any damage caused by the use of such additives will not be covered by the warranty.

Gearbox oil

Specifications

Manual gearbox and final drive

- Gear oil, API-GL 4, SAE 80 or
- Gear oil, G 50, SAE 75 W-90

Automatic gearbox

- Final drive: Gear oil, G 50, SAE 75 W-90
- Gearbox part: ATF Dexron®

Checking oil level

With a manual gearbox and final drive the oil level does not need checking.

With the automatic gearbox the oil level in the final drive does not need checking either.

The ATF level in gearbox part must however be checked in between the intervals given in Service Schedule. To do this the vehicle must be standing on a level surface. The level must only be checked when the ATF is **warm**. (Approximately 10 km after starting from cold, the ATF has reached the required temperature.) If fluid is cold or too hot the reading will be incorrect.

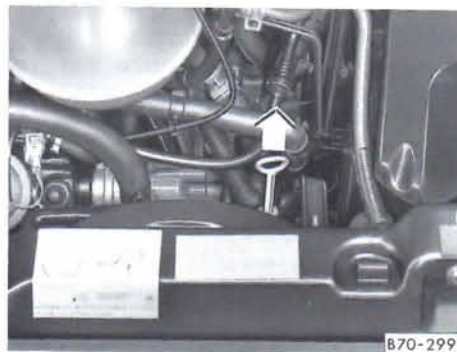

The engine must be running at idling speed, the handbrake must be applied and the selector lever at "N".

To check, pull dipstick (see Fig.) out, wipe with a clean lint-free rag and then insert it **fully** again.

Pull the dipstick out and check ATF level. **When the ATF is warm the level must be between the two marks** – otherwise the vehicle must be taken to a Volkswagen dealer without delay so that they can find the reason for the incorrect level. It is not sufficient to merely top up or drain off ATF.

Changing oil

For the manual gearbox with final drive the oil does not need changing.

For the automatic gearbox the oil in the final drive does not need changing either. The ATF in gearbox part must however be changed at the intervals given in Service Schedule.

Because of the disposal problems, the special tools necessary and the specialist knowledge required, the ATF changing should preferably be done by a Volkswagen dealer.

Notes

- **When there is no lubricant in the manual or automatic gearbox, the engine must not be started and the vehicle may only be towed with the driving wheels lifted.**
- **No additives may be mixed with the lubricants.**

Air cleaner



The paper filter element in the air cleaner is normally renewed as detailed in the Service Schedule. In very dusty conditions the element must be cleaned or renewed at shorter intervals.

To clean or renew element

- Release clip (1)
 - Press locking handle (2) down and unhook it.
 - Take filter housing out upwards.
 - Take filter element out.
 - Clean element with compressed air or renew it.
- The element must not be washed with petrol or moistened with oil.

Installing

- Insert filter housing. Ensure that the plastic lug on the rear end of the element fits in the recess in the mounting.
- Secure clip (1).
- Pull locking handle (2) up until it engages.

Power assisted steering



The reservoir is located in the engine compartment on the right looking forward.

The power assisted steering is filled with our hydraulic oil G 002 000.

The correct oil level in the reservoir is essential for the satisfactory operation of the power assisted steering.

The level can only be checked with the engine at normal operating temperature but not running.

Cooling system

There are two marks with which the oil level can be checked.

- Outside on container (Fig.)
 - Inside on dipstick attached to the cap.
- The oil level should always be between the "MAX." and "MIN" marks. When the level has dropped down below the "MIN" mark the power assisted steering should be checked at a Volkswagen dealer. It is not sufficient merely to top up with hydraulic oil.

Note

If the power assisted steering fails at any time or when engine is not running (vehicle on tow) the vehicle remains fully steerable but more force must be used to turn the steering wheel.

Under normal conditions the cooling system is almost maintenance-free.

The vehicle is fitted with a hinged radiator which can be folded forward when required – see page 104.

The cooling system is filled at the factory with a permanent coolant which is not changed. The coolant consists of water and a 40 % concentration of our coolant additive G 11 V8B (anti-freeze on glycol basis with anti-corrosion additives). This mixture not only gives the necessary frost protection down to -25 degrees C but also protects the alloy parts in the cooling system against corrosion. In addition it prevents scaling and raises the boiling point of the coolant.

The concentration of the coolant therefore must not be reduced in the summer or in warm countries, by topping up with plain water. **The coolant additive proportion must be at least 40 %.**

If greater protection against frost is required, the proportion of G 11 V8B additive can be increased, but only up to 60 % otherwise the anti-freeze protection is reduced and furthermore the cooling effect is impaired.

Vehicles for export to cold countries usually have frost protection down to -35 degrees C.

Only our **G 11 V8B** or an additive with the **specification TL-VW 774 B** (marked on container) should be added to the coolant. The additives can be obtained from Volkswagen dealers.

Other additives can be very detrimental to the anti-corrosion effect in particular.

The subsequent corrosion damage can lead to coolant loss resulting in major engine damage.



Checking coolant level

The expansion tank is in the engine compartment on the bulkhead – see Fig.

The correct coolant level is essential to the satisfactory operation of cooling system. For this reason, the coolant level should be checked regularly, and this is best done when refueling.

The level can only be checked properly when engine is not running.

The coolant level must be between the MIN and MAX marks on the expansion tank when engine is cold and can be slightly above the MAX mark when it is warm.

When the coolant level is too low on vehicles with an automatic coolant level monitoring device, it is indicated by the coolant temperature/coolant level warning lamp flashing continuously (see page 47).

Coolant losses

Coolant loss normally indicates leaks in the system. In this case the cooling system should be checked by a Volkswagen dealer without delay. It is not sufficient merely to add coolant.

In a sealed system losses can only occur if the boiling point of the coolant is exceeded as a result of overheating, and coolant is forced out of the system.

Overheating can occur if:

- the flow of cooling air is reduced, e.g. by a radiator muff, very dirty radiator fins (leaves, dust, insects) or additional driving lights in front of the cooling air intake.
- the boiling point of the coolant has been lowered by an incorrect mixture – see previous page.
- the radiator fan is not working – see "Fan" on next page – or,

■ the vehicle is driven up a long hill in too low a gear with engine speed very high and at very high ambient temperatures – see "Fan" on next page.

If the cause of the overheating cannot be found and eliminated, contact a Volkswagen dealer as soon as possible otherwise serious damage may be done to the engine.

Topping up coolant

Switch engine off and let it cool down. Then cover expansion tank cap with a cloth and turn cap carefully to the left and remove.

Attention

**Do not remove expansion tank cap when engine is hot – Danger of scalding.
System is under pressure.**

If, in an emergency only water can be added, the correct mixture concentration must be restored with the specified coolant additive (see previous page) as soon as possible.

If a lot of coolant has been lost, only add cold coolant after the engine has cooled down. This will prevent engine damage.

Do not fill above the MAX. mark.

The excess coolant will be forced out through the pressure relief valve in the cap when engine becomes hot.

Screw cap on again tightly.

Attention

The coolant additive and the coolant are a danger to health. The additive must therefore only be stored in the original container well out of reach of children. If the coolant has to be drained at any time it must be caught and also stored in a safe place.

 *Drained coolant should not normally be reused, it must be disposed of, bearing in mind environmental protection regulations.*

Fan

The radiator fan is driven electrically and controlled by a thermostich from the coolant temperature (also from the engine compartment temperature on some models).

Attention

After the engine has been switched off the fan can continue running for a while (up to about 10 minutes) with the ignition off. It can also start to run again suddenly after a short time, if the coolant temperature increases due to heat build-up. Special care must therefore be taken when working in the engine compartment.

Notes

- If the fan is not running although the coolant temperature is very high, the fuse should be checked and if necessary renewed – see page 122.
- The speed of the fan does not depend on engine speed. The cooling effect cannot therefore be increased by changing down. As long as the engine runs smoothly and a gradient can be taken without a large drop in speed it is not necessary to change down.

Driving in winter

To ensure that the frost protection is adequate, the coolant concentration should be checked and if necessary corrected, before the cold season begins.

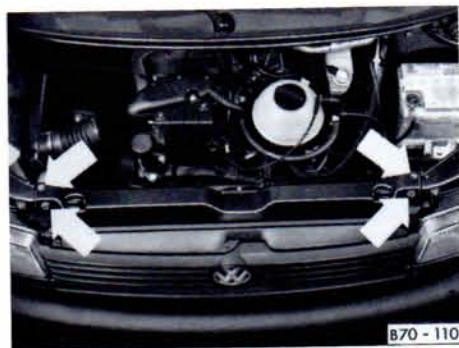

Moving radiator forwards

For certain operations in the engine compartment e.g. changing plugs or to reach the V-belt it may be necessary to move the radiator forwards.

To do this first remove the four securing screws (left illustration).



Then lift the radiator and move it forward.

When work in the engine compartment is finished the radiator must be moved back to the normal position and secured with the screws.

Brake fluid



The brake fluid reservoir is in the engine compartment.

Note

On vehicles with righthand drive the reservoir is on the other side of the engine compartment.

Checking fluid level

The correct fluid level is essential to the satisfactory operation of the brake system. The fluid level must always be between the "MAX" and "MIN" marks.

The level of fluid tends to sink slightly when the vehicle is used due to the automatic adjustment of brake linings. This is quite normal.

However, if the level sinks noticeably in a short time or drops below the "MIN" mark the system may be leaking. A low fluid level in the reservoir is indicated by the brake warning lamp lighting up (see page 48 also). When this happens take care to a Volkswagen dealer immediately and have the brake system checked.

Renewing brake fluid

Brake fluid absorbs moisture. In the course of time it takes in water from the ambient air. Too high a content of water in the brake fluid can in time cause corrosion damage in the system. Furthermore the boiling point of the brake fluid is reduced considerably. **For this reason the brake fluid must be renewed every two years.**

Attention

When the brake fluid becomes too old vapour bubbles can form in the brake system when the brakes are used hard. The efficiency of the brakes and thus the vehicle safety is then seriously affected.

Only use our genuine brake fluid (specification to US standard FMVSS 116 DOT 4). The fluid must be new.

Attention

Brake fluid is poisonous! It must therefore only be stored in the closed original container out of reach of children.

Remember also that brake fluid will attack the paintwork.

✿ Because of the disposal problems, the special tools necessary and the specialist knowledge required, the brake fluid changing should preferably be done by a Volkswagen dealer.

It is advisable to have the fluid change carried out during an Inspection Service.

Battery

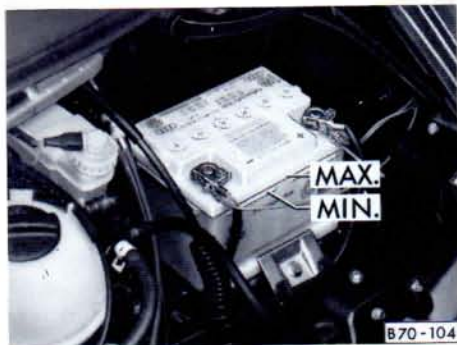

The battery is in the engine compartment on the left looking forward. It can be reached when the lid of the battery box is removed.

2nd battery*

The 2nd battery is located under the left seat.

To reach it the seat must be pushed fully forward past the stop. The stop must be freed. To do this – see page 21.

Attention

■ **Battery acid is corrosive and must not get into the eyes or onto skin and clothing.**

Any acid splashes must be washed off thoroughly with water. If necessary see a doctor.

■ **Never short the battery terminals (e.g. with tools) as this causes the battery to heat up very quickly and it may burst.**

■ **To prevent any possibility of short circuiting, detach battery earth cable before doing any work on the electrical system. When changing a bulb, it is sufficient to switch off the lamp concerned.**

■ **When disconnecting the battery from the vehicle electrical system first disconnect the negative cable and then the positive cable.**

The battery must not be disconnected with the engine running, as this will damage the electrical system (electronic components).

■ **When reconnecting the battery connect the positive cable first and then the negative cable. The connecting cables must on no account be interchanged – can cause wiring to burn out.**

Starting by connecting an additional battery is described in the Do-it-yourself section.

Checking acid level

In normal operating conditions the battery requires hardly any maintenance. At high ambient temperatures however it is advisable to check the acid level at regular intervals. It should always be between the MIN and MAX marks on the battery. If the acid level drops below the MIN mark, the affected cells must be topped-up to the MAX mark with distilled water.

It is recommended that the acid level is checked and corrected by a Volkswagen dealer.

Winter driving

Winter weather is particularly hard on the battery. Furthermore at low temperatures it has only a part of the capacity it has at normal temperatures. We recommend therefore that the battery should be checked preferably by a Volkswagen dealer before the onset of cold weather and charged if necessary. At the same time, if necessary, the terminals will be cleaned and special grease applied. This will not only result in quicker, more reliable starting but will help to prolong the life of the battery.

If the vehicle is not driven for several weeks when temperatures are very low, the battery should be taken out and stored in a frost-free room, so that it cannot freeze up and become damaged.

Attention
Store the battery out of reach of children.

To take battery out, first disconnect the two cables (see previous page) and then remove retainer.

Charging battery

When charging with a low current (e.g. with a small charger) the battery cables need not normally be taken off. The instructions from the charger manufacturer must however be noted.

Before **Quick charging**, that is charging with a high current, both battery cables must be disconnected – see previous page.

The following information must be noted:

- When charging the battery do not remove caps.
- A discharged battery can freeze at – 10 degrees C. It is essential to thaw out a frozen battery before it is given a quick charge otherwise it may explode!
- The mains cable of the charger should not be connected until after the clips of the charger have been properly secured to the battery terminals:
Red = plus (or positive)
Black = minus (or negative)
- Reconnect cables correctly after charging battery.

Attention

The gas given off during the charging process is highly inflammable so keep sources of ignition (naked flames, burning cigarettes etc.) well away from the battery.

Renewing a battery

If the battery has to be renewed, the new battery must have the same capacity, voltage (12 Volts), current capacity and shape. Volkswagen dealers have a range of suitable batteries.

 **Because of the problem of disposing of the old battery the renewal of a battery should preferably be done by a Volkswagen dealer. Batteries contain, amongst other things, sulphuric acid and lead and must on no account be put with normal household waste.**

GENERAL MAINTENANCE

Windscreen washer system



The fluid container is on the right of the engine compartment. The container holds about 5 litres, on vehicles with headlight washer system* about 7 litres.

The rear window washer is supplied with fluid from the container in the engine compartment.

Filling the container

Pull the cap off and fill container to the brim with washer fluid. Press cap on tightly again, then switch on ignition and check operation of washer system.

It is advisable to add a window cleaning solution with a wax remover (with anti-freeze additive in winter) to the water because plain water is not usually sufficient to clean the glass and headlight lenses quickly and thoroughly. The mixing ratios on the window cleaner packaging must be adhered to.

Even when **heated windscreen washer jets*** are fitted, a window cleaning solution containing anti-freeze should be added to the water in the winter.

Note

If at any time no window cleaning solution with anti-freeze additive is available, methylated spirits can be used. Do not, under any circumstances, add engine cooling system fluid or other additives.



Adjusting washer jets

When the vehicle is stationary, the water should hit the windscreen approximately as shown.

The jet for the rear window washer is in the wiper shaft. The water jet should hit the glass in the centre of the wiped area.

The jets can be adjusted with a needle.

The jets for the **headlight washer system*** can only be adjusted with a special tool. When adjustment is necessary, contact your Volkswagen dealer.

Windscreen wiper blades

Good wiper blades are essential for clear vision.

To prevent streaks from forming on the glass the wiper blades should be cleaned regularly with a window cleaning solution. When very dirty and full of insect remains, the blades can be cleaned with a sponge or cloth.

Jerky operation of the wiper blades can be caused by wax remains on the windscreen, after washing the vehicle in an automatic car-wash. Filling the windscreen washer container with a window cleaner containing a wax remover can cure the problem.

For safety reasons the wiper blades should be renewed once or twice a year. Wiper blades can be obtained from all Volkswagen dealers.

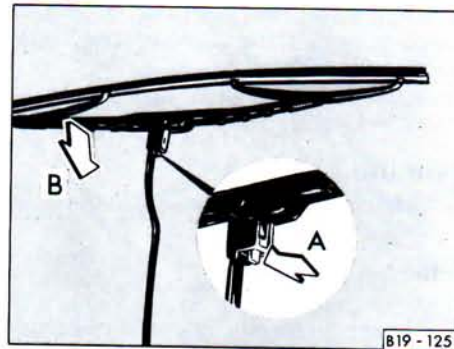

Changing wiper blades

Taking the wiper blade off

- Hinge the wiper arm up and position the blade horizontally.
- Press the retaining spring (arrow A) and push the blade towards the screen at the same time (arrow B).

Securing the wiper blade

The retaining spring must engage audibly in the wiper arm.

Wheels

General notes

■ New tyres do not give maximum grip straight away and should therefore be run in at moderate speeds and a careful style of driving for about the first 100 km. This will help to make the tyres last longer.

■ Check tyres for damage from time to time (cuts, splits, cracks and lumps) and remove any foreign bodies embedded in the treads.

■ To avoid damage to tyres and wheels drive over curbs and similar obstacles very slowly and as nearly at right angles as possible.

Damage to wheels and tyres is not always easy to see, so if you think that a wheel is damaged, it must be checked by a Volkswagen dealer.

■ Keep grease, oil and fuel off the tyres.

■ Replace missing dust caps as soon as possible.

■ Mark wheels before taking them off so that they rotate in the same direction when put back on again.

■ When taken off, the tyres should be stored in a cool, dry and preferably dark place.

Tyres which are not on wheels should be stored in a vertical position.

Tyre life

Tyre life depends to a considerable extent on the following factors:

Inflation pressure

The inflation pressure is very important particularly at high speeds. Therefore, the pressures should be checked at least once a month and before every long journey.

At this opportunity do not forget the spare wheel:

■ The spare wheel should always be inflated to the highest pressure required on the vehicle.

Always check the pressures when the tyres are cold. **When warm, the pressure is higher but do not reduce.** The pressures are given on page 147 and on a sticker on the driver's door lock pillar.

Pressures which are too high or too low shorten tyre life – quite apart from the detrimental influence on vehicle handling.

Attention

At continuous high speeds a tyre in which the pressure is too low flexes more and heats up excessively. This can cause tread separation and tyre blow out.

 **A pressure which is too low increases the fuel consumption and this burdens the environment unnecessarily.**

Mode of driving

Fast cornering, hard acceleration and violent braking also increase tyre wear.

Balancing wheels

The wheels on new vehicles are balanced. However when the vehicle is running various influences can cause the wheels to become unbalanced and this causes steering vibration.

As imbalance also increases steering, suspension and tyre wear the wheels should be balanced again. Furthermore a wheel should always be rebalanced when the tyre has been repaired or when a new tyre has been fitted.

Incorrect wheel alignment

Incorrect wheel alignment not only causes excessive, usually uneven tyre wear but can also impair the car's safe handling. If unusual tyre wear is noticed, contact a Volkswagen dealer.



Wear indicators

At the bottom of the tread of the original tyres there are 1.6 mm high "wear indicators" running across the tread – see fig. There are 6 – 8 of these indicators – according to make – evenly spaced around the tyre circumference. Marks on the walls of the tyre (for example the letters "TWI" or triangles) show the locations of the wear indicators.

Attention

- At the latest when the tyres are worn down to the wear indicators they must be renewed without delay.
- Worn tyres are detrimental to road holding particularly at high speeds on wet roads. In addition the vehicle tends to aquaplane sooner. We strongly recommend therefore that new tyres are fitted when the tread depth is down to 3 mm.

Note

When tread depth is down to 1.6 mm measured in the tread groove next to the wear indicator bar – the official permissible minimum tread depth has been reached (in export countries this figure may differ).

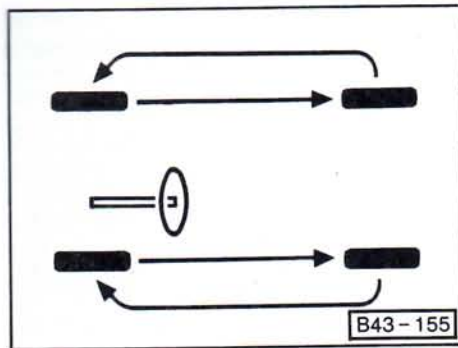

Changing the wheels round

If the front tyres are worn more than the rear it is advisable to change the wheels round as shown. All tyres will then have approximately the same length of service life.

With certain types of tread wear it can be an advantage to change the wheels diagonally. Volkswagen dealers have the necessary information.

Renewing wheels/tyres

Wheels and tyres are important design features. The wheels and tyres approved by us should be used. They are specially matched to the model concerned and contribute largely to the excellent road holding and safe driving characteristics.

Volkswagen dealers have the up-to-date information on which brands of tyres are approved by us.

■ Fitting and repairing tyres requires expert knowledge and special tools. This work may only be carried out by specialist personnel.

✿ ***Because of the problem of disposing of the old tyres, the special tools necessary and the specialist knowledge required, tyre changing should preferably be done by a Volkswagen dealer.***

Furthermore, many Volkswagen dealers stock an attractive range of wheels and tyres.

■ For safety reasons the tyres should be renewed in pairs and not singly. The tyres with the deepest tread should always be on the front wheels.

■ Only combine radial ply tyres of the same type, size (rolling circumference) and if possible the same tread pattern on all 4 wheels.

■ If the spare wheel differs from the version fitted on the vehicle (e.g. winter tyres or wide tyres) the spare may only be used briefly to replace a flat tyre and with an appropriately careful style of driving. It must be replaced with the normal wheel as soon as possible.

■ Never fit used tyres where their previous history is not known.

■ Knowing the **tyre lettering** and its meaning makes the selection of the correct tyres easier. Radial ply tyres have the following lettering on the sidewall:

e.g.: **195 / 70 R 15 97 S reinforced**

195	= Tyre width in mm
70	= Height/width ratio in %
R	= Radial construction code letter = Radial
15	= Wheel diameter in inches
97	= Carrying capability code
S	= Speed code letter
rein	= Reinforced version

The manufacturing date is also to be seen on the tyre wall (possibly only on inner side of wheel):

DOT ... 120 ... means that the tyre was produced in the 12th week of 1990.

Attention

Tyres which are more than 6 years old should only be used in an emergency and then with a particularly careful style of driving.

If you wish to fit your car with non-standard wheels or tyres please note:

Attention

■ **For technical reasons it is not normally possible to use wheels from other vehicles – in certain circumstances not even wheels from the same vehicle model!**

■ **Wheels and wheel bolts are matched to one another. On changing to a different type of wheel (e.g. alloy wheels or wheels with winter tyres) the correct bolt with the proper length and conical shape must be used.**

The security of the wheels and the functioning of the brake system depend on this!

■ **Using types of wheel and/or tyres which have not been approved by us for your vehicle model can be detrimental to the safety of the vehicle. It can also affect the vehicle under the Construction and Use regulations.**

■ **If wheel trim discs are subsequently installed it is essential to ensure that the air flow remains adequate to cool the brakes.**

Volkswagen dealers have all the necessary information about the possible conversion of wheels, tyres and wheel trims.

Winter tyres

In winter conditions winter tyres will distinctly improve the vehicle's handling. This applies in particular to vehicles that are equipped with wide tyres. Because of their construction (width, rubber mixture, tread formation etc.) these tyres provide less traction on ice and snow.

When fitting winter tyres note the following:

■ Only radial ply winter tyres may be fitted. The factory recommended tyre sizes are given on page 146.

■ To obtain the best possible handling characteristics, winter tyres must be fitted on all four wheels.

■ Winter tyres are no longer fully effective when the tread has worn down to a depth of 4 mm.

■ All-weather tyres can also be used instead of winter tyres.

■ If you have a flat tyre the remarks on using the spare wheel on page 112 should be noted.

■ Do not leave winter tyres fitted for an unnecessary long period because when the roads are free of snow and ice the handling with summer tyres is better.

 ***For environmental reasons summer tyres should be fitted again as soon as possible because normally they are quieter in running, tyre wear is reduced and the fuel consumption is lower.***

Snow chains

Snow chains may only be fitted on the front wheels.

Snow chains must not be fitted on 215/65 R 16 tyres. When necessary the vehicle must be equipped with smaller tyres – see Wheels, page 146.

Only use thin chains which do not stand clear more than 15 mm (including tensioner).

When using snow chains wheel trim plates and trim rings must be taken off. For safety reasons the wheel bolts must then be fitted with caps which are available from Volkswagen dealers.

When driving over roads which are free of snow you must remove the chains. On such roads they are detrimental to vehicle handling, damage the tyres and wear out quickly.

In Germany, the maximum permissible speed with snow chains is 50 km/h.

Arduous operating conditions

The vehicle construction and equipment is designed for normal operating conditions. This also applies to the frequency and the extent of the maintenance laid down in the Service Schedule.

If the vehicle is used in arduous operating conditions (e.g. continuous trailer towing, exceptionally high or low ambient temperatures, very dusty conditions, poor quality fuel, etc.) it may be necessary to carry out special technical preparations, such as changing the oil to the appropriate viscosity, installing special air cleaners, modifying the ignition timing etc. Furthermore, the maintenance must also be matched to the operating conditions – see also page 93.

Driving abroad

If the vehicle is to be taken abroad, the following must also be borne in mind:

■ If the vehicle has a catalytic converter, one must ensure that unleaded petrol will be available during the journey – see page 86. The automobile clubs offer information about the unleaded filling station network.

■ Although there are more than 10 000 Volkswagen dealers all over the world to service Volkswagen vehicles there are countries in which only a limited amount of service is available or none at all.

■ In certain countries it is also possible that your vehicle model is not sold so that certain spare parts will not be available or that the Volkswagen personnel are not familiar with the repair procedure should anything go wrong.

The Volkswagen Sales Centres in Germany or the Importer concerned will be only too pleased to give advice on the necessary technical preparation of the vehicle, on the maintenance required and on the repair possibilities.

The addresses are given in the vehicle wallet.

■ When the vehicle is used in a country which drives on the opposite side of the road to the home country the wedge shaped areas on the headlight lenses must be masked – see page 129.

Driving on holiday

Before starting off note the following points:

■ The roadworthiness and driving safety are particularly important when on holiday – see page 78.

■ With a fully laden vehicle and/or roof rack, the handling changes. The driving style must be adapted to the different conditions – more information on loading is given on page 28.

The tyre pressures must be checked – see page 147.

■ When a trailer is to be towed, there are many special points to note – see page 81.

■ If an oil change or an Inspection Service is probably going to become necessary during the trip, it is advisable to have this work done before going on holiday if possible.

Winter driving

In winter the following points should be noted:

■ Winter weather is particularly hard on the battery and it should therefore be checked, preferably by a Volkswagen dealer, before the onset of cold weather.

If the vehicle is not driven for several weeks when the temperatures are very low, the battery should be taken out – for further information see page 107.

■ On a vehicle with a Diesel engine, winter Diesel must be used at temperatures below 0 degrees C – see page 87.

■ The water should be drained out of the Diesel fuel filter before the onset of winter. This operation is also included in the Lubrication Service.

■ The anti-freeze in the cooling system should be checked before the cold season starts – see page 101.

■ The engine oil viscosity must be correct for the ambient temperature – see page 99.

■ Particularly in winter, frequent washing and waxing of the vehicle is the best way to protect it against harmful environmental influences.

■ In winter the windscreen washer system should always be filled with a window cleaning solution containing an anti-freeze additive.

■ To remove snow and ice from the windows and mirrors, a plastic scraper should be used – see page 90.

■ The road holding and handling can be improved in winter road conditions by the use of winter or All-weather tyres – see pages 114 and 146.

■ When driving in mountainous districts in winter it is advisable to take snow chains with you. On some such roads, snow chains are obligatory – see also page 114.

Accessories, modifications and renewal of parts

The Caravelle/Transporter is built in accordance with the most modern principles of safety technology and offers therefore a high degree of active and passive safety. To ensure that this remains so the vehicle as supplied by the factory may not be modified without careful thought. The following points must be noted if the vehicle is to be subsequently fitted with accessories, technically modified or have parts renewed later on:

■ Always consult a Volkswagen dealer **before** purchasing accessories and **before** any modifications are carried out because through close cooperation with us the Volkswagen Organisation is particularly competent in such matters.

Attention

In your own interests we recommend that only genuine accessories or only expressly approved Volkswagen accessories¹⁾ and Genuine Volkswagen Parts are used on your Caravelle/Transporter. The reliability, safety and suitability of these accessories and these parts has been specially determined for the Caravelle/Transporter.

■ **Despite continuous market observation we cannot assess or accept responsibility for other products even though in some cases approval has been given by a legally appointed test centre or an official permit has been given.**

■ Approved Volkswagen accessories and Genuine Volkswagen Parts can be obtained from Volkswagen dealers who will of course carry out the fitting correctly.

■ Additionally connected electric consumers e.g. cold box, horns, fans etc. must correspond to the electromagnetic compatibility as per DIN VDE 40 839. Otherwise functional defects can occur in the vehicle.

■ If technical modifications are to be made, our guidelines must be observed. This is to ensure that no damage occurs to the vehicle, the traffic and operating safety is retained and that the modifications are permissible. Volkswagen dealers will also carry out this work correctly or will recommend a specialist workshop.

Mobile telephones and two way radios

Mobile telephones or two-way radios must **not** be operated inside the vehicle without a separate external aerial.

When transmitting, these appliances radiate high frequency energy. This energy can, for physical reasons hardly pass through the sheet metal body and are reflected inside the body.

Attention

Mobile telephones and two-way radios operated inside the vehicle without a separate external aerial can be injurious to health!

Notes

■ **The high frequency transmitting energy radiated inside the vehicle can interfere with the functioning of the vehicle electronics.**

For these reasons and to avoid restricting the operating range of the mobile telephone or two-way radio, a special **external** aerial must be fitted to the vehicle.

DO-IT-YOURSELF

First aid kit, Warning triangle

The First Aid Kit and warning triangle can be secured under the front passenger's seat (not on vehicles with swivelling seats).

Note:

The first aid kit and warning triangle are **not** part of vehicle equipment.

Vehicle tools

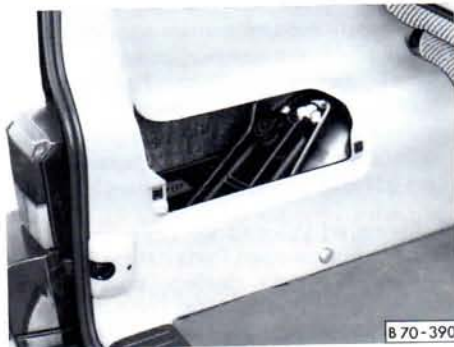

Vehicle tools and jack are stowed as follows:

Van, Kombi, Caravelle

at rear left of luggage compartment

Note

On vehicles with side trim panels the tools are stored behind a removable cover.

Double Cab

under rear seat

Pick-up

behind the driver's seat

Spare wheel

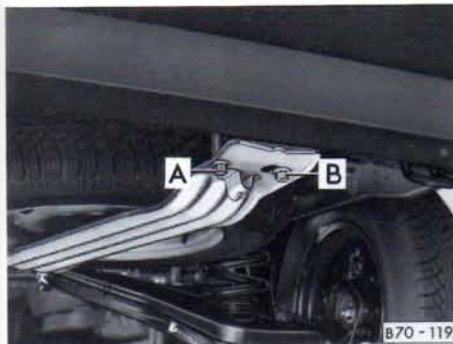

The spare wheel is secured under the rear of the vehicle in a special hinged carrier.

Lowering spare wheel carrier

Attention
When loosening the screws it is essential to keep to the following sequence:

- Loosen safety screw B until it turns freely.

Note

The safety screw B is held at the end with a clip so that it cannot be screwed out completely.



- Remove securing screw A completely. The spare wheel carrier then rests on the safety screw B.

Attention
If the screws are loosened in the opposite sequence, the carrier can fall off screw B.

- Then insert the wheel spanner in the carrier to the stop as shown in illustration on the right.
- Grip wheel spanner firmly with both hands, lift slightly and swing to the right until the large hole in the carrier can be swung over the safety screw and down.
- Take spare wheel out.

Lifting spare wheel carrier

- Insert wheel spanner in spare wheel carrier.
- Place wheel on carrier with well upwards, swing carrier up with wheel spanner and hook it on the safety screw.
- Screw in securing screw A first, then safety screw B.
- Then tighten both screws fully.

Attention

For safety reasons the spare wheel carrier must always be firmly secured so that the spare wheel cannot fall down accidentally.

Note

The rear mounting of the spare wheel carrier can be adjusted in height to cater for tyres of different widths.

Changing wheels

Park the vehicle as far as possible away from the traffic flow. If necessary switch on emergency warning lights and place the warning triangle in position – note legal requirements.

- All vehicles occupants should leave the vehicle and move to a safe area (e.g. behind the barrier).
- Apply handbrake firmly. If the car is on a slope, block one of the wheels on the opposite side with a stone or some similar object.
- Take the tools out of the vehicle.
- Take spare wheel out of carrier at rear of vehicle – see previous page.



- Push the wheel spanner as far as possible onto the wheel bolt as shown and turn the spanner anti-clockwise. When doing this, grip the spanner as far as possible towards the lever end.

If the bolts cannot be loosened, one can in an emergency, carefully push the spanner down with a foot on the end of the lever. One should ensure that one has a firm stance and a good grip on the vehicle.

Loosen wheel bolts about one turn.

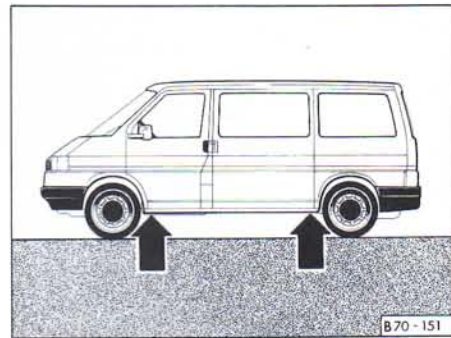

- Place jack under vehicle:
 - Depressions in the side member at front and rear indicate the points at which the jack must be fitted – see arrows in illustration.
 - On the sliding door side ensure that the claw of the jack does not fit under the sliding door.**
 - On the Pick-up the jack is placed under the mounting of the trailing arm (triangular mark) at the rear.
 - **If the jack is not placed at the marked points, the vehicle can be damaged.**



- Wind jack arm up by turning the crank handle until the jack just goes under the vehicle.
- The claw of the jack must fit round the vertical rib on the side member so that the jack cannot slip when vehicle is lifted – see illustration.
- If the ground is soft, place a large strong piece of packing under the jack base plate.
- Align jack and at same time wind claw up further until it contacts the vertical rib on side member.

- Lift vehicle until the defective wheel is clear of ground.
- Remove wheel bolts and place them on a clean surface (hub cap, cloth, paper) next to the jack and take the wheel off.
- Fit spare wheel and lightly tighten all bolts. The wheel bolts must be clean and easy to turn – do not under any circumstances use grease or oil!
- Lower vehicle and fully tighten bolts in diagonal sequence.
- Refit the wheel trim.
- Place defective wheel in spare wheel carrier and secure it – see page 119.

Notes

- Pay attention to the following after changing a wheel:
 - Check the tyre pressure immediately on the spare wheel which has been fitted.
 - Have the tightening torque of the wheel bolts checked with a torque wrench as soon as possible. The torque for steel and alloy wheels is 160 Nm.

If it has been established when changing the wheel that wheel bolts are corroded and hard to screw in, they must be renewed before checking the tightening torque.

Until these checks have been carried out one should, for safety reasons, only drive at a moderate speed.

- The defective wheel should be repaired as soon as possible.

Attention

If the vehicle is to be subsequently fitted with wheels or tyres which differ from those fitted by the factory, it is essential to read the remarks in the centre and right hand columns on page 113.

Fuses



The individual current circuits are protected by fuses..

The central electrics with the relays is on the left in the footwell behind a hinged shelf.

It is advisable to always carry a few spare fuses on the vehicle. These can be obtained from any Volkswagen dealer.



Changing a fuse

- Switch off the component concerned.
- Take box or lid off by turning knob 90 degrees to right or left, then pull and unhook box or lid out of retainers at the bottom.
- With the aid of the list of fuses (see next page), determine which fuse belongs to the component that has failed.

- Pull out the fuse concerned.
- Replace blown fuse – can be recognised by the burnt metal strip – with a fuse of **same** amperage.
- Insert box or lid by turning knob again 90° to right or left, hook box or lid on at bottom, swing up and press knob in.

Notes

- If the newly inserted fuse blows again after a short time, the electrical system must be checked by a Volkswagen dealer as soon as possible.
- **On no account should fuses be patched up because this can cause serious damage elsewhere in the electrical system.**
- Some of the components listed are only found on certain models or are optional extras.

Fuse layout

(from left to right)

No.	Component	A¹⁾
1-	Dipped beam left, headlight range control left	10
2-	Dipped beam right, headlight range control right	10
3-	Instrument and number plate lighting	10
4-	Rear wiper, seat heating	15
5-	Windscreen wiper, windscreen and rear window washer/elec. heated washer jets	15
6-	Blower, air conditioner	30
7-	Tail and side light right, engine compartment light	10
8-	Tail and side light left	10
9-	Rear window heating, mirror heating	20
10-	Fog lights, rear fog light	15
11-	High beam left, high beam warning lamp	10
12-	High beam right	10
13-	Horn, radiator fan (run-on)	10

¹⁾ Ampère

No.	Component	A¹⁾
14-	Reversing lights, electric outside mirrors, sliding/tilting roof, shift pattern auto. gearbox, cruise control system (cancel contacts on the brake and clutch pedal)	10
15-	Engine electronics	10
16-	Warning lamps, dash panel insert, glove box light	15
17-	Turn signals	10
18-	Electric fuel pump, Lambda probe	20
19-	Radiator fan, air conditioner	30
20-	Brake lights	10
21-	Interior and luggage compartment lights, make-up mirror light, clock, radio, central locking	15
22-	Cigarette lighter	10

Additional fuses

(in separate holders)

	A¹⁾
■ above the relays	
Fuse for electric windows	20
■ In the engine compartment on the bulkhead above the brake servo:	
Glow plugs ²⁾	50
■ Under the driver's seat	
Fuse for additional water heater	10
Fuse for heater blower	30
Fuse for water heater glow plug	20
Fuse for auxiliary heater ³⁾	25

Fuse colour code:

Red:	10 Ampère
Blue:	15 Ampère
Yellow:	20 Ampère
Green:	30 Ampère

²⁾ This fuse should only be renewed by a Volkswagen dealer.³⁾ On vehicles with swivelling seats this fuse can be found in the side trim behind the driver's seat.

Changing bulbs

Before starting to replace a bulb, switch off the light concerned.

Do not touch the glass part of the new bulb with bare fingers because the finger marks left on the glass evaporate when the bulb becomes hot, the vapour settles on the reflector and dims it.

Always use the same type of bulb. The designation is marked on the base of the bulb or on the glass.

It is advisable to always carry a box of spare bulbs in the vehicle. These can be obtained from Volkswagen dealers. It should contain at least the following bulbs which are essential for traffic safety:

12 V 60/55 W	Headlight (H4)
12 V 21W	Turn signal
12 V 21/5W	Brake and tail light
12 V 4W	Side light
12 V 5W Glass base	Number plate light

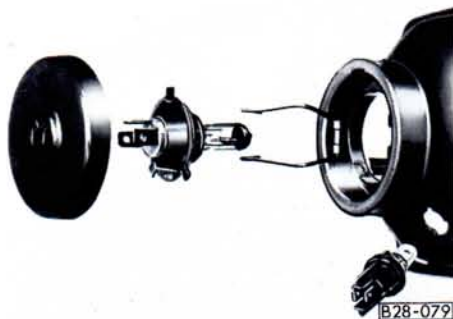

Side light bulb

The side light bulbs are located in the headlight reflectors.

- Turn the bulb holder fully to the left and take it out of the reflector.
- Press the defective bulb into the holder, turn it to left and take it out.
- Insert the new bulb.
- Insert the bulb holder in the reflector and turn the holder fully to the right.

Headlights

The headlight bulbs can be reached through the opened bonnet.

- Pull off the connector.
- Pull cap off.
- Squeeze the spring clip of the bulb holder together and pull down.
- Take the bulb out and insert the new bulb so that the locating lug on the bulb plate engages the recess in the reflector. The centre of the three terminals on the bulb base is then at the top.
- Fold the spring clip over bulb base. Squeeze the clip together and engage it in the retaining lugs.
- Press the cap back on.
- Attach the connector.
- Have the headlight beam alignment



Front turn signals

To change a bulb the turn signal housing must be taken out to the front.

- Insert the flat blade of a screwdriver between headlight and turn signal with bonnet open. This presses the securing tabs which hold the turn signal housing to the side.
- Swing screwdriver to front as shown in illustration so that the turn signal housing is pressed out forward.

- Turn bulb holder out to the left.
- Turn bulb out and renew.
- Insert bulb holder.
- Insert turn signal housing in the grooves provided (top and bottom) and press it in until the securing tabs engage.

Fog lights*

The foglight bulbs can be taken out from underneath the bumper.

- Turn cap on rear of fog light to the left to remove it.
- Unhook spring clip of bulb holder and swing it away.
- Take bulb out.
- Insert new bulb so that the locating lug on bulb plate engages recess in the reflector.
- Swing spring clip over bulb plate, squeeze it together and engage it in the retaining lugs.
- Fit cap again.
- Have beam alignment checked.



Rear lights

Renewal of the bulbs for the rear lights is done from the luggage compartment through the rear panel trim.

- Reach into the hole in the rear panel trim with one hand and squeeze the two retaining tabs of bulb carrier together.
- Take bulb carrier out (illustration).
- Press defective bulb into holder slightly, turn it to the left and take it out.
- Insert new bulb and turn fully to the right
- Install bulb carrier.



Rear fog light

- Renewal of the bulbs for the rear lights is done from the luggage compartment through the rear panel trim.
- Take housing out.
- Turn bulb holder out to the left.
- Take bulb out and renew.
- Turn bulb holder back in.
- Insert left side of housing in the recess first and press in firmly until the tabs engage.

Number plate lights

The lights are secured with 2 screws.

- Take lens off
- Pull complete light out
- Pull bulb housing out
- Pull defective bulb out and renew
- Insert bulb housing
- Secure lens firmly



Interior and reading light*

Interior light (A)

- Insert a knife blade or something similar into gap between housing and lens and carefully lever lens off.
- Change bulb.
- Press lens into housing again, when doing this the lug on the lens must fit in the recess in the housing.

Reading light (B)

- Remove light as described under "Interior light large version".
- Turn white bulb holder on back of light to the left and take it out.
- Pull defective glass based bulb out of holder.
- Insert new bulb.
- Install holder in housing again and turn fully to the right.
- Press interior light into opening in headlining again.

**Interior light without reading light****Small version**

- Press retaining lug on opposite side to switch towards centre of light and remove light.
- Renew bulb.
- Insert switch side of light first and press in until the retaining lug locates.

**Large version**

- Take light off by inserting flat screwdriver blade between light and headlining and turning screwdriver.
- Insert a screwdriver on the right hand side, between the reflector and housing, and by twisting the screwdriver, pivot the reflector out (see illustration).
- Change the bulb.
- Swing the reflector back into position, ensuring that it engages properly.
- Press the interior light into the opening in the roof trim again.

Adjusting headlights

The setting of the headlights is very important to traffic safety. The adjustment should therefore only be done with a special appliance. Note official regulations when setting headlights.

On vehicles with beam control* the knurled disc on the instrument panel must be in the basic position (→).

Both illustrations show the adjustment on the right hand headlight. On the left hand headlight the adjustment is symmetrically opposite.



Main headlights

The headlights are adjusted from the front with a suitable Phillips screwdriver (from vehicle tools). The bonnet must be released or open..

A – Vertical adjustment

Turning clockwise lowers the headlights.

B – Lateral adjustment



Fog lights*

The front foglights are adjusted by a knurled wheel mounted on the foglight behind the bumper. To adjust, push the flat end of a screwdriver through the opening adjacent to the foglight (see Fig.) and rotate knurled wheel.

On vehicles without a spoiler the knurled wheel can also be turned by hand.

To reduce the beam range, turn screw to the left.

Masking headlights

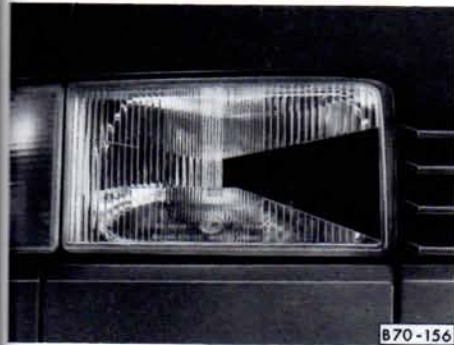

When the vehicle is used in a country which drives on the opposite side of the road to the home country, the asymmetric dipped headlights will dazzle oncoming traffic.

To prevent this, the wedge-shaped sector on the headlight lenses must be covered up with an opaque adhesive strip.

The illustration shows the strip installed for the change from right hand to left hand traffic.

Installing radio

When service installing a radio or replacing a set installed by the factory the following points should be noted:

■ The connection* in the vehicle is for Genuine Volkswagen radios¹⁾ from Model Year 1988. The supply plug has the following wire colours and connections:

Red/white	Permanent positive (+)
Brown	Negative (-) vehicle earth
Grey/blue	Instrument panel lighting
Brown/red*	Control wire for "Ignition key" switching radio on/off. On no account use this connection for operating voltage supply.
Blue/white*	Speed signal for automatic volume control

■ Radios with other connections must be connected with an adapter cable which can also be obtained from a Volkswagen dealer.

¹⁾ Not available in all export markets

Attention

On no account cut wires off and leave them without insulation. If necessary use a proper adapter. Otherwise the wiring can be overloaded or short circuits can occur - Fire danger!

Apart from this important electronic components can be damaged or the functioning impaired. If for example the speed signal is disturbed this can lead to faulty management of engine, automatic gearbox, ABS etc. Even connecting the speed signal to radio sets with speed dependent volume control from other manufacturers can cause such faults.

■ The radios from the Genuine Volkswagen Accessory Programme¹⁾ are similar to those used in the factory and ensure trouble-free installation. These sets are in keeping with the advanced technology and well-planned easy-to-operate design. In Germany there is also an Exchange Service for these radios so that even after years of use a set requiring repair can be exchanged cheaply for a completely reconditioned, good-as-new set by a Volkswagen dealer.

■ Loudspeakers, fitting parts, aerials and suppression kits should also be taken from the Genuine Volkswagen Accessory Programme¹⁾. These parts have all been specially developed for each vehicle model.

■ When installing the aerial it is essential to ensure that the hole provided by the factory where the aerial enters the body is sealed very carefully. In addition the aerial cable, the connecting wires and the loudspeaker wires must be routed so that they cannot chafe, rattle or get tangled up with moving parts (e.g. pedals, steering, heating controls etc.). Otherwise the operation of the controls may be affected or vehicle safety impaired.

In cases of doubt, exact information can be obtained from Volkswagen dealers.

Emergency starting

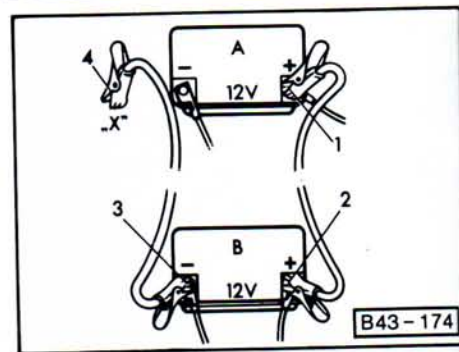

A – Flat battery
B – Boosting battery

The battery is located in the engine compartment.

If the engine will not start because the battery is flat, **jumper cables** can be connected to the battery of another vehicle to start the engine. The following points should be noted:

■ Both batteries must be of the 12 Volt variety and the capacity (Ah) of the booster battery must be approximately the same as that of the flat battery.

■ The jumper cables must be heavy enough to carry the load. Note cable manufacturer's data.

¹⁾ Not available in all export markets

- Only use jumper cables with insulated clips.
- A flat battery can freeze at -10 degrees C and if a battery is frozen it must be thawed out before connecting jumper cables, otherwise it could explode.
- There must be no contact between the vehicles, otherwise current can flow as soon as the plus terminals are connected.
- The flat battery must be properly connected to the electrical system.
- The engine of the boosting vehicle must be running.
- The jumper cables must only be connected as follows:
 1. One end of (+) cable (usually red) to the (+) terminal of the flat battery.
 2. Other end of the red cable to the (+) terminal of boosting battery.
 3. One end of (-) cable (usually black) to the (-) terminal of boosting battery.
 4. Other end of black cable (X) to a solid metal part bolted to the block or to cylinder block itself.

Do not connect the cable to the flat battery minus terminal. The sparks could ignite the explosive gas flowing out of the battery.

Attention

- **The non-insulated parts of the cable clips must not touch one another on any account. Furthermore the jumper cable attached to the battery positive terminal must not come into contact with electrically conductive vehicle parts - Short circuit danger!**
- **Route the jumper cables so that they cannot come into contact with rotating parts in the engine compartment.**
- **Do not stand with your face over the battery - danger of acid burns!**
- **Keep sources of ignition (naked flames, burning cigarettes etc.) well away from the battery - Explosion danger!**

- Start the engine as described in the "Starting engine" section.
- If the engine does not start at once, stop using starter after 10 seconds, wait about half a minute and then try again.
- With engine running, disconnect cables in reverse sequence.

Tow starting/towing

General notes

■ Towing eyes are provided on the right under front and rear bumpers. Tow-ropes or bars should be attached at these points only.

On vehicles with a factory fitted towing bracket a towing eye is not fitted. On those vehicles the towing bracket can be used for towing.

■ The tow-rope should be slightly elastic to reduce the risk of damage to both vehicles. It is advisable to use synthetic fibre ropes, or ropes of similar elastic material. **It is however safer to use a tow-bar!** Avoid excessive towing effort and do not jerk. During towing operations on other than surfaced roads there is always the danger that the attachment points will be overloaded and damaged.

■ **Before trying to start engine by towing, the battery from another vehicle should be used for starting if possible – see previous page.**

If the vehicle has to be tow started or towed at any time, the following must be noted:

■ Check whether there are any local traffic regulations concerning the towing of vehicles.

■ Both drivers must be familiar with towing procedures. Inexperienced drivers should not attempt to tow start or tow.

■ When using a tow-rope the driver of the towing vehicle must engage the clutch very gently when moving off and changing gear.

■ The driver of the vehicle being towed must ensure that the tow-rope is always taut.

■ The emergency lights must be switched on on both vehicles – unless local regulations differ.

■ Turn ignition key to "Drive" position so that the steering wheel is free and the turn signals, horn, and, if necessary, the windscreen wiper and washer can be used.

■ As the brake servo only works when the engine is running, considerably more pressure is required on the brake pedal when the engine is not running.

■ On vehicles with power assisted steering more force is required to turn steering wheel when engine is not running.

■ When there is no lubricant in the manual or automatic gearbox, the vehicle may only be towed with driving wheels lifted.

Tow starting

The following points must be noted when tow starting:

- **Before** moving off, engage 2nd or 3rd gear.
- Switch ignition on.
- As soon as engine starts, depress clutch and move gear lever into neutral to avoid running into the towing vehicle.
- **On vehicles with a catalytic converter the engine must not be started by towing the vehicle in excess of 50 m¹. Because then, unburnt fuel can pass into the converter and cause damage.**
- **For technical reasons tow starting a vehicle with an automatic gearbox is not possible.**

Towing

When towing vehicles with an automatic gearbox, the following points must be noted in addition to the details on the previous page:

- Selector lever at "N".
 - Do not have the vehicle towed faster than 30 mph (50 km/h).
 - To not tow further than 30 miles (50 kilometers).
- If the vehicle has to be towed long distances it must be lifted at the front.

Reason: When the engine is not running, the gearbox oil pump is not working and the gearbox is not adequately lubricated for high speeds or long distances.

- With a breakdown vehicle the vehicle may only be suspended at the front.
- Reason: If given a rear suspended tow, the drive shafts turn backwards. The planetary gears in the automatic gearbox then turn at such high speeds that the gearbox will be severely damaged in a short time.

¹⁾ Does not apply to 50 kW Diesel engine with catalytic converter

Lifting vehicle

Trolley jack

To prevent damage to the underside of the vehicle it is essential to use a suitable rubber pad.

On no account should the vehicle be lifted under the engine, gearbox, rear axle or front axle as this can cause serious damage.

Attention

■ **With the vehicle lifted never start the engine – danger of accident!**

■ **If work has to be done underneath the vehicle, the vehicle must be supported on suitable stands.**

Vehicle lift

Before driving over the vehicle lift, ensure that there is adequate clearance between lift superstructure and low parts on underside of vehicle.

To lift the Caravelle/Transporter only twin column/pillar hoists with sufficiently long support arms should be used.

Only as an exception – for short wheel base vehicles in unladen condition – can a single column hoist be used.

Hoists with fluid cushions (Repair reception hoists) must not be used to lift this vehicle.



Lifting points for workshop hoist and trolley jack

The vehicle may only be lifted at the points shown here.

Front

At the front cross member (illustration)

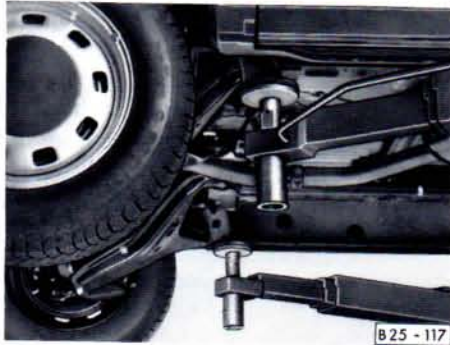

Rear

At mounting for the rear trailing arm (left illustration)

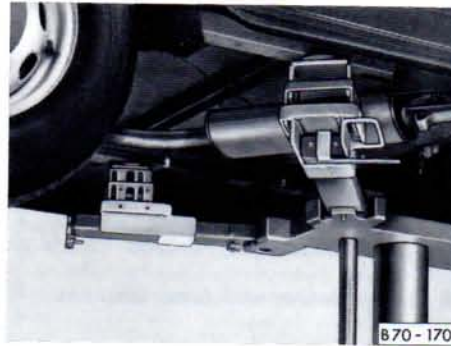

Short wheelbase vehicles, when unladen can as an exception be lifted on a single column hoist.

The lifting point is then at the side member at reinforcement plate (illustration).

Vehicle jack

Lifting with the vehicle jack is described on page 120.

Engine

- 4 stroke petrol/Diesel engine, transverse installation
- 4/5 cylinders in-line
- Cast-iron cylinder block
- 5/6 bearing crankshaft
- Sheet metal sump
- Alloy cylinder head
- Valves operated via toothed belt and overhead camshaft
- Maintenance free valve gear with hydraulic tappets
- Cooling system filled for life of vehicle
- Radiator with separate expansion tank
- Electric radiator fan controlled by thermostat switch
- Maintenance free electronic ignition
- Long-life spark plugs
- Optical and acoustic oil pressure warning
- Low maintenance battery with high starting capacity
- Long-life low maintenance V-belts
- Thermostatically controlled intake air preheating
- Dry air cleaner with paper element
- **Fuel injection engines** have fully electronic engine management (combined control of injection and ignition systems).
- Emission control system with Lambda probe on petrol engines (not in all Export markets)
- **Diesel engines** with distributor injection pump with cold start aid, filter preheating, self-bleeding fuel system
- Long life exhaust system.

Emission control system<122>

The exhaust emission control system effectively reduces the amount of pollutants in the exhaust gas.

Petrol engines

The main parts of the emission control system are

- a mixture formation system which guarantees very exact composition of the air/petrol mixture at all engine speeds
- the catalytic converter
- the Lambda probe¹⁾

The catalytic converter is installed in the exhaust system. It consists of a steel-cased ceramic or metal body containing a multitude of longitudinal passages which are vapour coated with a thin layer of platinum or rhodium.

The exhaust gas flows through the catalytic converter and reacts with an afterburning process when it contacts the precious metal coating.

¹⁾ Lambda = Air/petrol relationship

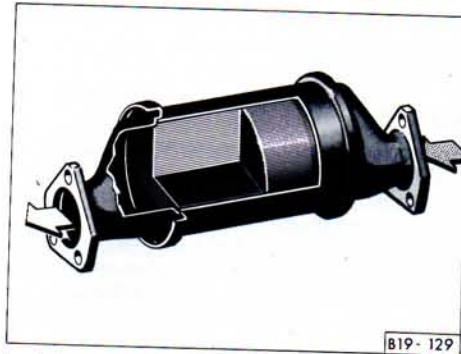

In this process three pollutants (three-way catalytic converter) are converted as follows.

- Carbon monoxide to carbon dioxide
- Hydrocarbons to water
- Nitrogen oxide to nitrogen (four fifths of the air we breathe is nitrogen).

A stipulation for the proper functioning of the catalytic converter, however, is that the exhaust gas has a certain specific composition and minimum temperature when it enters the catalytic converter. To obtain this composition, exact regulation of the fuel/air mixture is required. A very exact regulation is obtained with a Lambda probe.

The Lambda probe* is fitted in the exhaust pipe where it measures the exhaust gas composition continuously. The information signal is fed to an electronic control unit which in turn regulates the mixture formation system so that the mixture is kept constantly correct.

The exhaust emission control system technology is so well developed that no additional maintenance whatsoever is required. To maintain the effectiveness of the emission control system, the following must be noted:

- Only fill up with unleaded petrol – see page 86.
- Never run tank completely empty – see page 85.
- Do not overfill engine oil – see page 98.
- Do not switch off ignition whilst driving – see page 39.
- Do not tow start vehicle for more than 50 m – see page 133.

Attention

Due to high temperatures which can occur in the catalytic converter in very unfavourable conditions, the vehicle should not be parked so that the catalytic converter can come into contact with inflammable materials.

If whilst driving, the engine misfires, loses power and runs unevenly, this could be due to a fault in the ignition system. In a case like this, unburnt fuel can enter the exhaust system and then escape to atmosphere. Furthermore, the catalytic converter could become damaged due to overheating. The vehicle speed must be reduced immediately and the defect should be eliminated at the nearest Volkswagen dealer.

Note

Even in the case of a perfectly working exhaust emission control system there can, under certain engine operating conditions, be a sulphur-type exhaust smell.

This depends upon the sulphur content in the fuel being used.

Quite often this can be remedied by selecting another brand of fuel or, filling up with unleaded premium petrol.

50 kW Diesel engine

An oxidation catalytic converter is fitted in the exhaust system of this Diesel engine. It consists of a steel-cased ceramic body containing a multitude of longitudinal passages which are vapour coated with platinum. The catalytic converter largely eliminates the unpleasant smelling hydrocarbons and turns carbon monoxide into carbon dioxide.

In addition an exhaust gas turbocharger forces air into the cylinder, causing the engine to operate with a high excess of air. The fuel which is then injected in is so completely burnt, that under full load soot is no longer visible in the exhaust.

As the diesel engine catalytic converter does not get hotter than a conventional exhaust system, under normal conditions there is nothing special to be noted, this applies also to parking.

The system does not require any additional care or maintenance.

Activated charcoal filter*

Vehicles with a regulated catalytic converter, in Germany and other export countries, have a fuel system which includes an activated charcoal filter (petrol vapour accumulator).

The activated charcoal filter prevents the fuel vapour escaping into the atmosphere.

These vapours pass into a container filled with activated charcoal and, when the engine is stationary they are accumulated in the activated charcoal. When the engine is running, the container is automatically ventilated by opening a valve and the fuel vapour is fed into the engine for combustion.

The system works completely automatically and is maintenance-free.

Power flow

Manual gearbox

- Mechanically or hydraulically operated single plate dry clutch
- Baulk synchronized five speed manual gearbox and final drive in one housing.
- Common lubrication for gearbox and final drive. Permanent oil filling
- Front wheel drive

Automatic gearbox*

- Hydro-dynamic torque converter with lock-up clutch to eliminate converter slip in 3rd speed (under certain driving conditions) and (always) in 4th speed
- Planetary gearbox with 4 forward gears
- Two electronically controlled selectable driving programmes
- Flanged on final drive with separate lubrication and life-long oil filling
- Front wheel drive

Steering, Axles

Steering

- Maintenance free rack and pinion steering
- Steering column with angled joints
- Steering pinion and column connected by angled shaft with two universal joints
- Hydraulically assisted steering (PAS)*

Front axle

- Independent wheel suspension with double wishbones, shock absorbers and anti-roll bars
- Longitudinal mounted torsion bar

Rear axle

- Independent suspension with diagonally trailing arms, coil springs and shock absorbers.

Brakes

- Hydraulic dual circuit brakes
- Disc brakes at front
- Self adjusting drum brakes at rear
- Brake servo
- Pressure/load-sensitive brake pressure regulator for rear axle
- Mechanical handbrake effective on rear wheels
- Anti-locking brake system (ABS)*

Body

- Unitary construction body/ chassis
- Floor frame reinforced by side and cross members
- Long term body protection with special high-quality materials – this makes possible the long warranty period for paint defects and rust penetration (see Service Schedule)

Environment compatibility

Protection of the environment played a decisive role in the construction, selection of materials and manufacture. Amongst other things special attention was given to the following points:

Constructive measures for economic recycling

- Disassembly-friendly design of joints
- Easier disassembly by modular construction methods
- Improved purity of materials
- All larger plastic parts marked in accordance with VDA recommendation 260.

Selection of material

- Refrigerant for air conditioner* CFC free
- Materials which can be recycled are used as far as possible
- Use of similar plastic within an assembly group
- Use of materials which have been recycled
- PVC not used, when possible to use an alternative material
- No Cadmium
- No Asbestos
- No leaded paint
- Reduction in vapours emitted by plastics

Manufacture

- Recycled material used for the manufacture of plastic parts
- Solvents abandoned for the cavity sealing
- Use of water based paints
- Solvent free transport preservation
- Use of solvent free bonding agents
- CFCs abandoned as far as possible during manufacture
- Surplus material recycled as far as possible to gain energy and manufacturing support materials
- The water required during manufacture is reprocessed.

General information

Where not otherwise indicated or listed separately, all the following technical data is for standard vehicles in Germany.

For special vehicles and vehicles for other countries these figures may be different.

Please note that the details in the official vehicle documents can be taken as the correct figures.

Which engine is fitted in your vehicle can be found in the vehicle data in the Service Schedule or in the official vehicle paperwork.

ENGINE DATA

	Output ¹⁾ kW (BHP) at rpm	Maximum torque Nm at rpm	Number of cylinders	Capacity cm ³	Stroke mm	Bore mm	Compression	Fuel ²⁾
Petrol engines with regulated catalyst	62 (84) / 4300	159/2200	4	1968	95.5	81.0	8.5	91 RON unleaded
	81 (110) / 4500	190/2200	5	2461	95.5	81.0	8.5	91 RON unleaded
Diesel engines	45 (61) / 3700	127/1700-2500	4	1896	95.5	79.5	22.5	Diesel
	50³⁾ (68) / 3700	140/2000-3000	4	1896	95.5	79.5	22.5	Diesel
	57 (78) / 3700	164/1800-2200	5	2370	95.5	79.5	22.5	Diesel
Petrol engines without catalyst⁴⁾	62 (84) / 4300	159/2200	4	1968	95.5	81.0	8.5	91 RON unleaded/leaded

¹⁾ According to EC or DIN regulations.
Due to different methods of measuring, slight deviations are possible.

²⁾ For further details – see page 86.

³⁾ With catalyst

⁴⁾ Only for some export countries

Performance

Maximum speed

in km/h

flaps, very wide tyres etc. which affect the performance.

The performance figures were measured without the vehicle being fitted with any equipment such as air conditioner, mud

		Caravelle, Kombi, Multivan, Delivery van	Pick-up	High roof Kombi, High roof Delivery van	Double cab
Petrol engines with catalytic converter					
62 kW	Manual gearbox	144	128	137	132
81 kW	Manual gearbox	158	142	151	146
	Automatic	154	138	147	142
Diesel engines					
45 kW	Manual gearbox	128	115	122	117
50 kW	Manual gearbox	132	119	126	121
57 kW	Manual gearbox	137	124	131	126
	Automatic	133	120	127	122
Petrol engines without catalytic converter					
62 kW	Manual gearbox	144	128	137	132

Fuel consumption

Passenger vehicle models

The consumption figures are determined according to EC guideline 80/1268 EEC. Three different conditions are used for the test:

■ The measurements for **90 km/h (56 mph)** and

■ **120 km/h (75 mph)** are carried out at a constant test speed.

■ For the **urban** measurement normal town traffic driving is simulated.

Depending on driving style, road and traffic conditions, environmental influences and vehicle condition, the figures obtained in

actual practice may differ from those given.

All figures were measured with standard tyres. On vehicles with other tyres the figures will vary accordingly.

Consumption in litres per 100 km		Caravelle, Kombi, Multivan			High roof Kombi		
		90 km/h	120 km/h	Urban	90 km/h	120 km/h	Urban
Petrol engines with catalytic converter							
62 kW	Man. gearbox	9.1	13.7	14.4	10.1	15.2	14.9
81 kW	Man. gearbox	9.4	13.4	15.9	10.4	14.9	10.4
	Automatic	10.5	14.1	15.9	11.5	15.9	11.5
Diesel engines							
45 kW	Man. gearbox	6.5	—	9.1	7.3	—	9.4
50 kW	Man. gearbox	²⁾	²⁾	²⁾	²⁾	²⁾	²⁾
57 kW	Man. gearbox	7.5	10.8	10.7	8.4	12.5	10.4
	Automatic	8.6	12.7	11.5	9.6	—	11.5
Petrol engines without catalytic converter							
62 kW	Man. gearbox	9.1	13.7	14.4	10.1	15.2	14.9

¹⁾ Only applies to vehicles which have a top speed in excess of 130 km/h (81 mph).

²⁾ The figures were not available at time of going to print.

Commercial vehicle models

These consumption figures were determined in accordance with DIN 70030 Part 2 (July 1978 Edition) with half payload at a constant 3/4 of top speed (but not more than 80 km/h) plus 10 %.

Depending on driving style, road and traffic conditions, environmental influences and vehicle condition, the figures obtained in actual practice may differ from those given.

All figures were measured with standard tyres. On vehicles with other tyres the figures will vary accordingly.

Figures ltr./100 km		Delivery van	High roof Delivery van	Pick-up	Double cab
Petrol engines with catalytic converter					
62 kW	Manual gearbox	13.5	13.2	13.5	15.9
81 kW	Manual gearbox	15.0	14.8	13.2	15.6
	Automatic gearbox	14.7	14.6	15.5	15.6
Diesel engines					
45 kW	Manual gearbox	7.9	8.2	9.4	8.7
50 kW	Manual gearbox	¹⁾	¹⁾	¹⁾	¹⁾
57 kW	Manual gearbox	9.4	10.4	10.7	10.7
	Automatic gearbox	10.8	11.9	12.3	1.3
Petrol engines without catalytic converter					
62 kW	Manual gearbox	13.5	13.2	13.5	15.9

³⁾ The figures were not available at time of going to print.

Spark plugs

The spark plugs are renewed during the Volkswagen Inspection Service

If the spark plugs have to be renewed between the Inspection Services, the following should be noted:

■ Engine, spark plugs and ignition system are matched to one another. To avoid faulty operation and even engine damage only the Genuine Volkswagen spark plugs for the engine concerned should be used. Important, among other things, are the number of electrodes, the heat value and if necessary the radio suppression.

■ The plugs may be, for technical reasons, changed at short notice during the current model year. It is therefore advisable to obtain plugs only from Volkswagen dealers – they have the latest information

Engine	Genuine Part Number
62 kW	101 000 026 AA/N 9 BMC
81 kW	101 000 001 AE/14-8 DTU
	101 000 005 AE/W8 DTC
	101 000 007 AB/N7 BYC
	101 000 027 AB/BP 5 ET

V-belts

■ The V-belts are among the most severely stressed parts of a vehicle. The belts must therefore be subjected to very high quality requirements.

■ When renewing a belt it is not sufficient to use just any belt of the same size. For safe operation only the special Genuine Volkswagen belt for the vehicle concerned should be used. The correct belts can be obtained from Volkswagen dealers under the Genuine Part number given.

■ The V-belts may be, for technical reasons, changed at short notice during the current model year. It is therefore advisable to obtain V-belts only from Volkswagen dealers – they have the latest information.

Wheels

The tyre/wheel combinations in the table are valid for steel and alloy wheels. Details on whether other tyres or wheels can be used can be obtained from Volkswagen dealers.

For winter tyres the most suitable tyre/wheel combination is given. The winter tyre recommendation applies also to All-weather tyres. Further remarks on the use of winter tyres are given on page 114.

Attention

If you wish to fit your car with non-standard wheels or tyres (e.g. alloy wheels or wheels with winter tyres), you must read the appropriate notes in the centre and right hand columns on page 113.

Snow chains

Snow chains may only be fitted on the front wheels.

Snow chains **must not** be fitted to 215/65 R 15 size tyres. If necessary smaller tyres must be fitted.

Tyres	on wheel	Winter tyres/wheels
185 R14 C 99/97N (or 99/97P)	5 1/2 J x14	185 R 14 / 5 1/2 J x 14
195/70 R 15 97S reinforced	6 J x 15	205/65 R 15 / 6 J x 15
205/65 R 15 98S reinforced	6 J x 15	205/65 R 15 / 6 J x 15
215/65 R 15 100T (or 102H) re- inforced	7 J x15	205/65 R 15 / 6 J x 15

Tyre pressures

Attention

The tyre pressures must be checked at least once a month. They are very important particularly at high speeds – see page 110.

These pressures are for cold tyres. When tyres are warm the pressure is higher but do not reduce it.

The inflation pressures are given on a sticker on the inside of the driver's door lock pillar. As the pressures may be altered at short notice for technical reasons there may

be differences between sticker and Instruction Manual. If this should be the case, ask your Volkswagen dealer for the correct pressures.

Tyre pressures for vehicles with a permissible axle load¹⁾ on one axle of less than 1285 kg

Tyres	Pressure in bar		
	Front	Rear	Spare
185 R 14 C 97/99N (or 97/99P)	3.0	3.8	3.8
195/70 R 15 97 S reinforced	2.6	3.4	3.4
205/65 R 15 98 S reinforced	2.6	3.4	3.4
215/65 R 15 100 T (or 102H) reinforced	2.4	3.0	3.0

Tyre pressures for a vehicle with a permissible axle load¹⁾ on one axle of 1285 kg or more

Tyres	Pressure in bar		
	Front	Rear	Spare
185 R 14 C 97/99N (or 97/99P)	3.4	3.8	3.8
195/70 R 15 97 S reinforced	3.0	3.4	3.4
205/65 R 15 98 S reinforced	3.0	3.4	3.4
215/65 R 15 100 T (or 102H) reinforced	2.4	3.0	3.0

¹⁾ The permissible front and rear axle loads are given on page 148.

Weights

Vehicles with 4 cylinder engines (Figures for 5 cylinder engine in brackets)

Normal payload (in kg)	Wheelbase in mm	Permissible GVW	Unladen weight (with driver)	Payload	Permissible front axle load	Perm. rear axle load	Perm. roof load ²⁾
Caravelle	2920	2465 (2540)	1565 ¹⁾ (1640) ¹⁾	900 (900)	1350 (1430)	1300	100
	3220	2565 (2640)	1665 ¹⁾ (1740) ¹⁾	900 (900)	1430 (1520)	1300	100
lowered suspension	2920	2365 (2440)	1565 ¹⁾ (1640) ¹⁾	800 (800)	1280 (1350)	1200	100
Multivan ³⁾	2920	2500 (2540)	1705 ¹⁾ (1780) ¹⁾	800 (760)	1350 (1430)	1300	100
lowered suspension ³⁾	2920	2430 (2505)	1705 ¹⁾ (1780) ¹⁾	725 (725)	1350 (1430)	1200	100
Kombi	2920	2525 (2590)	1520 ¹⁾ (1595) ¹⁾	995 (995)	1280 (1350)	1380	100
	3320	2565 (2640)	1570 ¹⁾ (1645) ¹⁾	995 (995)	1350 (1430)	1380	100
High-roofed Kombi	3320	2565 (2640)	1620 ¹⁾ (1695) ¹⁾	945 (945)	1350 (1430)	1380	–
Van	2920	2525 (2590)	1520 (1595)	995 (995)	1280 (1350)	1380	100
	3320	2565 (2640)	1570 (1645)	995 (995)	1350 (1430)	1380	100
High-roofed Van	3320	2565 (2640)	1620 (1695)	945 (945)	1350 (1430)	1380	–
Pick-up	2920	2465 (2540)	1470 (1545)	995 (995)	1200 (1280)	1380	50
	3320	2525 (2590)	1520 (1595)	995 (995)	1280 (1350)	1380	50
Low loader	3320	2525 (2590)	1520 (1595)	995 (995)	1280 (1350)	1380	50
Chassis and cab	2920	2465 (2540)	1315 (1390)	–	1200 (1280)	1380	50
	3320	2525 (2590)	1340 (1415)	–	1280 (1350)	1380	50
Double cab	3320	2515 (2590)	1590 (1665)	925 (925)	1350 (1430)	1460	75
Chassis with Double Cab	3320	2515 (2590)	1460 (1535)	–	1350 (1430)	1460	75

Remarks and footnotes – see page 150

www.vwT4camper.info - a useful website for owners and enthusiasts of VW T4 Transporter Campervans

Vehicles with 4 cylinder engines (Figures for 5 cylinder engines in brackets)

Increased payload (in kg)	Wheelbase in mm	Permissible GVW	Unladen weight (with driver)	Payload	Permissible front axle load	Perm. rear axle load	Perm. roof load ²⁾
Caravelle	2920	2650 (2700)	1565 ¹⁾ (1640) ¹⁾	1085 (1060)	1350 (1520)	1460	100
	3320	2750 (2800)	1665 ¹⁾ (1740) ¹⁾	1085 (1060)	1430 (1520)	1460	100
Kombi	2920	2700 (2775)	1520 ¹⁾ (1595) ¹⁾	1180 (1180)	1430 (1430)	1460	100
	3320	2750 (2800)	1570 ¹⁾ (1645) ¹⁾	1180 (1155)	1430 (1430)	1460	100
High-roofed Kombi	3320	2750 (2800)	1620 ¹⁾ (1695) ¹⁾	1130 (1105)	1430 (1520)	1460	–
Van	2920	2700 (2775)	1520 (1595)	1180 (1180)	1350 (1430)	1460	100
	3320	2750 (2800)	1570 (1645)	1180 (1155)	1430 (1430)	1460	100
High-roofed Van	3320	2750 (2800)	1620 (1695)	1130 (1105)	1430 (1430)	1460	–
Pick-up	2920	2650 (2725)	1470 (1545)	1180 (1180)	1280 (1350)	1460	50
	3320	2700 (2775)	1520 (1595)	1180 (1180)	1350 (1430)	1460	50
Low loader	3320	2700 (2775)	1520 (1595)	1180 (1180)	1350 (1430)	1460	50
Chassis and cab	2920	2650 (2725)	1315 (1390)	–	1280 (1350)	1460	50
	3320	2700 (2775)	1340 (1415)	–	1350 (1430)	1460	50

Remarks and footnotes – see page 150

Vehicles with 4 cylinder engines (Figures for 5 cylinder engine in brackets)

Reduced payload (K800) (in kg)	Wheelbase in mm	Permissible GVW	Unladen weight (with driver)	Payload	Permissible front axle load	Perm. rear axle load	Perm. roof load ²⁾
Van	2920	2320 (2395)	1520 (1595)	800 (800)	1200 (1280)	1200	100
Kombi	2920	2320 (2395)	1520 ¹⁾ (1595) ¹⁾	800 (800)	1280 (1350)	1200	100

Notes

■ Other model versions and optional extras – e.g. air conditioner, automatic gearbox, sliding roof, towing bracket etc. and service installation of accessories increases the unladen weight and the payload has to be reduced by this amount.

■ The load must be stowed so that it cannot slide about or fly forward when the brakes are applied. If necessary use the lashing eyes provided.

■ When carrying heavy loads, the load should, in the interests of good handling, be placed, where possible, between the axles. The permissible axle and gross vehicle weights must not be exceeded on any account. Bear in mind also that the load will alter the vehicle handling. Driving style and speed must therefore be adapted to suit.

¹⁾ Without driver

²⁾ Use only the roof load carrying system approved by us. Distribute load evenly. Do not exceed permissible roof load including roof rack – and permissible vehicle weight. For further details see page 75

³⁾ On vehicles with a pop-up roof the unladen weight is increased by 60 kg and which correspondingly reduces the payload.

Trailer weights

Figures in kg	Permissible trailer weight ¹⁾ max.		Permissible combined weight ²⁾		Permissible nose weight of tow bar on ball coupling of towing bracket	
	Trailer without brakes	Trailer with brakes	Gradients up to 10 %	Gradients up to 12 %	max.	min.
62 kW petrol engine	700	2000	–	4500	100	4% of actual trailer weight. However it need not be more than 25 kg. It is advisable to fully utilize the maximum per- missible nose weight
81 kW petrol engine	700	2000	–	4500	100	
45 kW Diesel engine	700	2000	4500	4500	100	
50 kW Diesel engine	700	2000	4500	4000	100	
57 kW Diesel engine	700	2000	–	4500	100	

¹⁾ Detailed information on trailer towing is given on page 81 .

²⁾ The combined weight is made up of the permissible gross vehicle weight of the towing vehicle and the permissible gross weight of the trailer. When the permissible trailer payload is fully utilized, in some cases the weight of the towing vehicle must be correspondingly reduced. However, the towing vehicle must not be lighter than the trailer.

TECHNICAL DATA

Dimensions¹⁾

in mm	Wheelbase in mm	Length	Width	Height		Ground clear- ance ²⁾	Overhang		Track		Turning circle in m
				with- out canopy	with can- opy		front	rear	front	rear	
Caravelle	2920	4655	1840	1940	–	180	860	875	1575	1540	11.7
	3320	5055	1840	1940	–	180	860	875	1575	1540	12.9
with lowered suspension	2920	4655	1840	1920	–	160	860	875	1575	1540	11.7
Multivan	2920	4655	1840	1940	–	180	860	875	1575	1540	11.7
Kombi	2920	4655	1840	1940	–	180	860	875	1575	1540	11.7
	3320	5055	1840	1940	–	180	860	875	1575	1540	12.9
High roofed Kombi	3320	5055	1840	2400	–	180	860	875	1575	1540	12.9
Van	2920	4650	1840	1940	–	180	860	875	1575	1540	11.7
	3320	5055	1840	1940	–	180	860	875	1575	1540	12.9
High roofed van	3320	5055	1840	2400	–	180	860	875	1575	1540	12.9
Pick-up	2920	4845	1970	1910	2125	180	860	1065	1575	1540	11.7
	3320	5245	1970	1910	2125	180	860	1065	1575	1540	12.9
Low loader	3320	5245	1970	1910	–	180	860	1065	1575	1540	12.9
Double cab	3320	5245	1970	1920	2120	180	860	1065	1575	1540	12.9

¹⁾ The details given refer to the basic model. Special model versions and optional extras – e.g. different wheel sizes – can result in deviations.

²⁾ When loaded to permissible GVW. When negotiating steep ramps, driving over poor surfaces, curbs etc., particularly with vehicles with a spoiler and heater mounted un-

derneath the floor, care must be taken not to "bottom" and thus cause damage to these fittings.

Capacities

(in litres)

Fuel tank of that reserve	about 80 about 10
Windscreen washer with headlight washer	about 5 about 7
Engine oil (with/without filter change) 4 Cylinder engines 5 Cylinder engines	about 5.0/4.5 about 5.5/5.0
The oil level must be checked while topping up. Do not overfill (see page 97) !	
Automatic gearbox (ATF)	about 3.0

TECHNICAL DATA

Vehicle identification data



The type plate

is secured to the front passenger's door lock pillar.

Vehicles for certain export countries have no Type plate.

1	SORT. NR.	
2	FAHRZG.-IDENT. NR. VEHICLE-IDENT. NO.	
3	TYP./TYPE	
4		
5	MOTORKB. / GETR. KB. ENG. CODE / TRANS. CODE	
6	LACKNR./INNENAUSST. PAINT NO./ INTERIOR	
7	M - AUSST. / OPTIONS	

817-183

The vehicle data sticker

is stuck underneath the instrument panel near the central electrics.

The sticker contains the following data:

- 1- Production control number
- 2- Vehicle identification number
- 3- Model code number
- 4- Model explanation/engine output
- 5- Engine and gearbox code letters
- 6- Paint number/interior trim code
- 7- Optional extra number

The vehicle data 2 – 7 is also given in the Service Schedule.

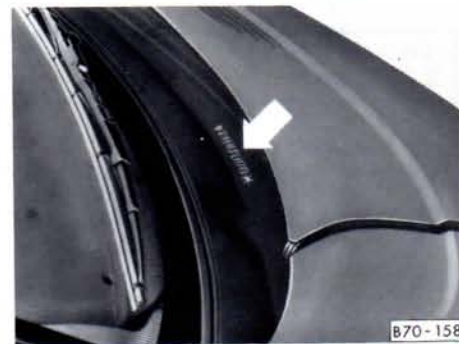

The vehicle identification number

(Chassis number)

is stamped on the outside on right below the windscreen.

The engine number

is stamped in the block below the cylinder head or is on a sticker on the toothed belt guard.

Adjusting the brake pressure regulator

The Caravelle/Transporter is fitted with a pressure/load sensitive brake pressure regulator (brake pressure reducer) which limits the brake pressure on the rear axle to the set value. See also sticker on the end of the left door below the lock. The regulator is set at the factory so that normally even after fitting a body, The brakes should work perfectly.

Only in special cases when it is found during a road test that the braking effect on the rear axle is too low or too high, must the regulator be reset by a Volkswagen dealer.

ALPHABETICAL INDEX

A

Acceleration figures	142
Accessories	117
Activated charcoal filter	138
Additional heater	62
Additional water heater	67
Adjusting brake pressure regulator	155
Adjusting headlights	128
Adjusting washer jets	108
Air cleaner	100
Air conditioner	57
Air distribution	55
Alloy wheels	91
Analog clock	46
Anti-dazzle inside mirror	13
Anti-freeze	101
Anti-locking brake system (ABS)	30
Arduous operating conditions	115
Armrests	21
Ashtrays	73
ATF	99
Automatic gearbox	32
Automatic wash plants	88
Auxiliary heater	63
Axle loads	148

B

Battery	106
Belt height adjustment	16
Blower	55
Bonnet	94
Brake fluid	104

Brake servo	30
Brake system	104
Brake warning lamp	48
Brakes	29, 139

C

Capacities	153
Capacity	141
Care of body	88
Care of car	88
Catalyst	137
Cavity preservation	92
Central locking system	8
Cetane Number	87
Changing bulbs	124
Changing front turn signal bulb	125
Changing wheels	120
Chassis number	154
Checks when filling the tank	160
Child safety	18
Child seats	18
Child-proof catch	9
Cigarette lighter	73
Cleaning and anti-corrosion treatment of engine compartment	91
Clock	46
Cold starting aid	38
Combined weight	151
Compression ratio	141
Consumption figures	143
Coolant additive	101
Coolant level	47, 102

Coolant temperature - Gauge	41
Cooling system	101
Cruise control system	53

D

Dash panel	4
Dashboard and controls	4
Defrosting windows	56, 58
Diesel fuel	87
Dimensions	152
Dip lever	52
Dipstick	
- Automatic gearbox	99
- Engine	97
Direction indicators	48
Do-it-yourself	118
Door locks	9
Doors	9
Drawbar weight	83
Driver's seat	20
Driving abroad	115
Driving on holiday	115
Driving safely	78
Driving tips	76

E

Electric socket	73
Electric window lifters	12
Emergency lights	51
Emergency starting	130
Emission control system	137

Engine			
- Code letters	154	- <i>Petrol vapour accumulator</i>	138
- Data	141	- <i>Tyre pressure</i>	110
- Intervals of oil change	93	- <i>Tyres</i>	112
- Number	154	- <i>Unleaded fuel</i>	86
- Oil	96	- <i>Washing the vehicle</i>	89
- Oil capacity	153	F	
- Oil change intervals	98	Fan	103
- Oil consumption	97	Filling the tank	85
- Oil level	97	Filter preheating	87
- Oil pressure	47	First aid kit	118
- Starting/stopping	37	Fog lights	51, 125
Engine compartment	95	Folding seat	25
Engine compartment light	72	Foot mats	29
Engine number	154	Fresh air ventilation	56
 <i>Environment</i>		Front axle load	148
- <i>Activated charcoal filter</i>	138	Front seats	20
- <i>Battery</i>	107	Fuel	86
- <i>Brake fluid</i>	105	- Additives	86, 87
- <i>Care of car</i>	88	- Consumption	79, 143
- <i>Coolant</i>	103	- Filter	116
- <i>Driving environment consciously</i>	79	- Filter preheating	87
- <i>Driving with low emissions/noise</i>	79	- Gauge	46
- <i>Emission control system</i>	137	- Saving	79
- <i>Engine oil</i>	98	Fuses	122
- <i>Filling the tank</i>	85	G	
- <i>Fuel</i>	86	Gear change marks	40, 77
- <i>Maintenance</i>	93	Gear lever	31
- <i>Old oil</i>	98	Gearbox oil	99
- <i>Old tyres</i>	112	Glove box	74
		Glow plugs	38
		H	
		Handbrake	31
		Head restraints	19
		Headlight beam control	50
		Headlight flasher	52
		Headlight washer system	54
		Heated rear window	51
		Heating	55, 57
		High beams	48
		Horn	4
		I	
		Identification data	154
		Ignition lock	36
		Increased payload	149
		Inertia reel belts	16
		Inside mirror	13
		Inspection intervals	98
		Installing seat	22
		Instrument lighting	50
		Instruments	40
		Interior lights	72, 126
		Intervals of inspection	93
		Intervals of oil change	93
		J	
		Jack	120
		Jacking points	120
		Jumper cable	130

ALPHABETICAL INDEX

K

Keys	7
Kick-down	34

L

Lambda probe	86, 137
Lap belt	17
Lashing eyes	28
Lifting vehicle	134
Lighting	50
Lighting switch	50
Loading/sleeping surface	26
Lubricant additives	99
Lubricants	96
Luggage compartment	28
Luggage compartment cover	27

M

M & S tyres	116
Maintenance	93
Make-up mirror	73
Manual gearbox	31
Masking headlights	129
Maximum engine speed	77
Maximum speed	142
Mileage recorder	40
Mirror heating	14
Mirrors	13

Mobile telephones	117
Modifications	117
Moving radiator forwards	104
Multi function indicator	42

N

Number plate lights	126
---------------------------	-----

O

Octane rating	86
Oil capacity	153
Oil change intervals	98
Oil consumption	97
Oil pressure	47
Oil specifications	96
Oils	96
Output	141
Outside mirror	13

P

Paint care	89
Paint number	154
Parking	138
Parking lights	52
Parking lock	33
Payload	148
Pedal	29
Performance figures	142
Permissible GVW	148

Petrol	
- Additives	86
- Consumption	143
- Quality	86
Petrol vapour accumulator	138
Pivoting seats	21
Power assisted steering	100
Power flow	139

R

Radio	129
Rear axle load	148
Rear fog light	51, 126
Rear lights	125
Rear seat bench	23
Rear window wash/wipe	54
Recirculating air switch	61
Removing seat	22
Renewal of parts	117
Restraint systems	18
Rev counter	46
Reverse gear	34
Reversing lights	31
Roof load	75, 148
Roof load carrying system	75
Roof rack	75
Running-in	76

S

Safety for children	18
Seat adjustment	20
Seat belts	15
Seat heating	51
Seat stop	21
Seats	20
Selector lever	33
Service address list	2
Service Schedule	2
Side lights	50
Sleeping surface	26
Sliding door	9
Sliding window	13
Sliding/tilting roof	71
Snow chains	114
Spare wheel	119
Spark plugs	145
Speedometer	40
Starting the engine	37
Steering/starter lock	36
Stopping engine	39
Sun roof	70
Sun visors	73
Switches	50

T

Tachograph	45
Tailgate	10
Tank capacity	153
Technical Data	141
Technical description	136
Telephone	117
Tilting roof	70, 71
Timer	65, 68
Tools	118
Tow starting	133
Tow-bar weight	151

Towing	133
Trailer socket	81
Trailer towing	81
Trailer weights	151
Tread depth	111
Trip recorder	40
Trolley jack	134
Turn signal lever	52
Turn signals	48, 125
Two way radios	117
Type plate	154
Tyre pressures	147
Tyres	110
- Condition	111
- Inflation pressure	110
- Pressures	147

U

Unbalanced wheels	111
Undercoating	92
Unladen weight	148
Unleaded fuel	86

V

V-belts	145
Vehicle data sticker	154
Vehicle identification data	154
Vehicle identification number	154
Vehicle lift	134
Vehicle literature	2
Vehicle tools	118
Ventilation	55, 56, 57

W

Warning and control lights	6
Warning lamps	6, 47
Warning triangle	118
Warranty	2
Washing	88

Weights	148
Wheelbase	148
Wheels	110, 146
Windows	12
- De-icing	90
- Defrosting	56, 58
Windscreen washer system	108
Windscreen wiper	54
Windscreen wiper blades	109
Wing doors	11
Winter driving	116
Winter tyres	114
Wipe/washer system	54

ROUTINE CHECKS WHEN FILLING THE TANKS

In order to ensure that your vehicle remains ready for the road at all times between Inspections you should carry out a few checks regularly – preferably when filling the tank.



We have listed the most important points to be checked here. How to open the bonnet is explained on page 94.

Attention

Take particular care when working in the engine compartment – see page 95.

1 – Coolant reservoir (expansion tank)

Attention

Do not open expansion tank when engine is hot – danger of scalding!

If the level is below the min. mark, top it up with coolant additive G 11 V 8 B and water – see page 101. When unavoidable plain water can be used temporarily.

2 – Brake fluid reservoir

The fluid level must always be between the min. and max. marks – see page 104.

3 – Engine oil level

Every engine uses a certain amount of oil. If the level is too low it can lead to serious engine damage. For this reason the level must be checked regularly – see page 97.

4 – Engine oil filler opening

The approved types of oil are given on page 96.

5 – Windscreen washer container

Always fill with water and a glass cleaner. Think about frost precautions in winter.

6 – Tyre inflation pressures

Check the pressures at least once a month. The pressures are given on page 147 and on a sticker on the driver's door lock pillar. For further information, see page 110.

You can enter the most important data for **your** vehicle here.
 If you have any questions, any Volkswagen Dealer will be pleased to help.

Vehicle identification number¹⁾		Engine oil specifications²⁾	
Model		<input type="checkbox"/> To Volkswagen Standard 501 01	
Engine output¹⁾ kW Engine code letters¹⁾		<input type="checkbox"/> To Volkswagen Standard 500 00	
Mixture preparation²⁾		<input type="checkbox"/> To Volkswagen Standard 505 00	
<input type="checkbox"/> Injection <input type="checkbox"/> Diesel		Viscosity: SAE	
<input type="checkbox"/> With catalyst		Tyre size⁴⁾	
Fuel²⁾		
<input type="checkbox"/> Regular unleaded ³⁾ 91 RON		Tyre pressures⁴⁾	
<input type="checkbox"/> Diesel		(in bar)	front rear
¹⁾ This data can be found in the Service Schedule. ²⁾ Mark with cross ³⁾ Leaded also for engines without catalytic converter. ⁴⁾ Factory fitted tyres.		With half load	
		With full load	

VOLKSWAGEN AG is working continuously on the development of all models. Please appreciate that we must reserve the right to change our models in shape, equipment and technology at any time. No legal commitment is therefore implied by the details, illustrations and descriptions in this manual.

Reprinting, reproducing or translation, in whole or in part, is not permitted without written permission from VOLKSWAGEN AG. All rights are reserved expressly by VOLKSWAGEN AG. Subject to modification without notice.

Produced in Germany

© 1992 VOLKSWAGEN AG



This paper was manufactured from pulp bleached without using chlorine

www.vwT4camper.info - a useful website for owners and enthusiasts of VW T4 Transporter Campervans

Caravelle/Transporter englisch 8.92
931.551.701.20

www.vwT4camper.info - a useful website for owners and enthusiasts of VW T4 Transporter Campervans